

Michaels®

Embroidery Design
Sewing Information

Production Worksheet

Wilcom TrueSizer



Design: **Spyglass**

Title: **Spyglass**

Stitches: 7,454
 Height: 1.62 in
 Width: 3.81 in
 Colors: 8
 Colorway: Colorway 1
 Zoom: 1:1

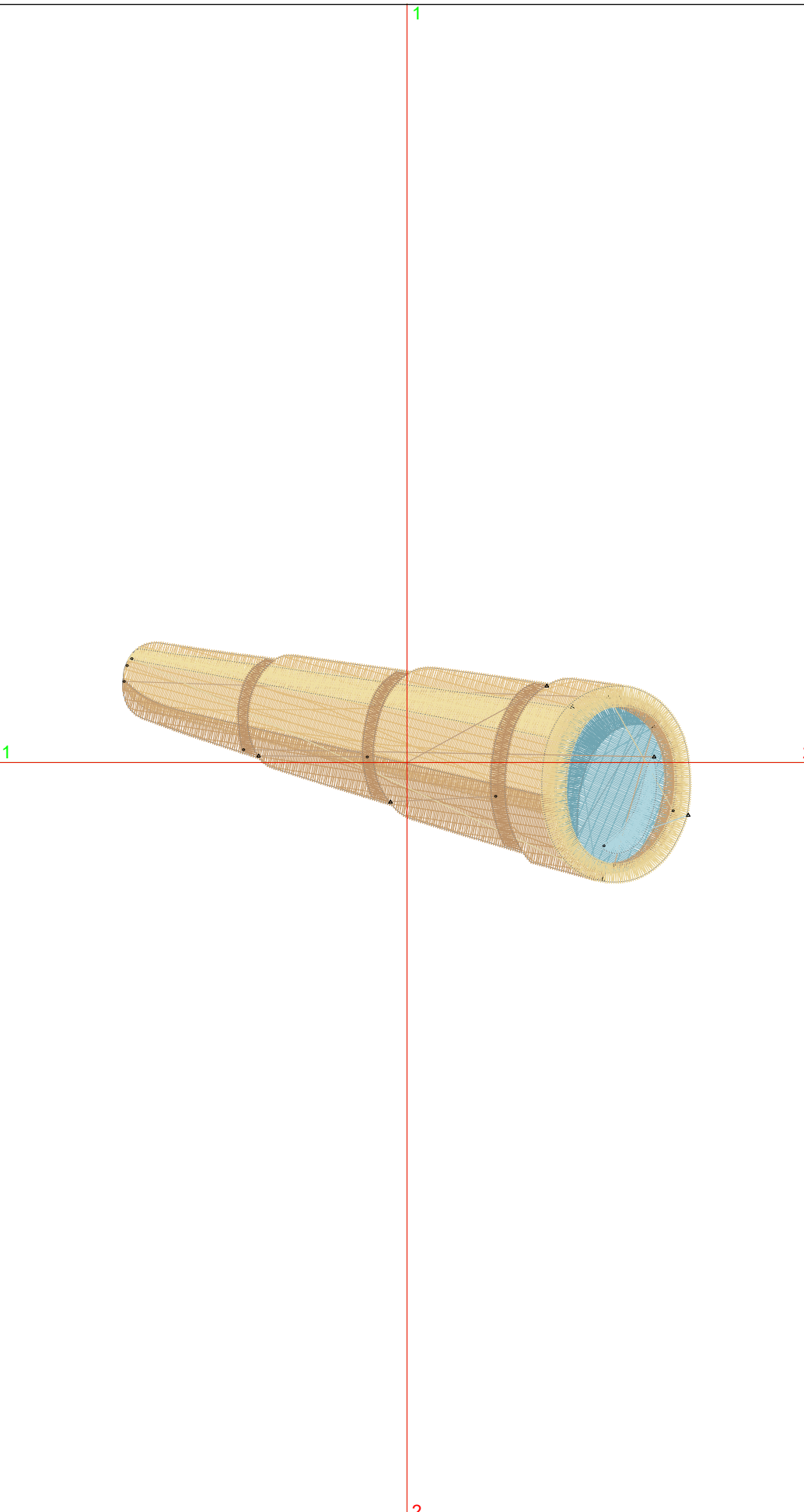

Machine format: Tajima
 Color changes: 8
 Stops: 9
 Trims: 11
 Auto fabric: Pure Cotton
 Required stabilizer: Topping:
 Backing: Tear Away x 2
 Appliqués: 0
 Left: 48.4 mm
 Right: 48.4 mm
 Up: 20.6 mm
 Down: 20.6 mm
 EndX: 0.00 in
 EndY: 0.00 in
 Area: 6.17 in²
 Max stitch: 7.0 mm
 Min stitch: 0.2 mm
 Max jump: 7.0 mm
 Total thread: 149.93ft
 Total bobbin: 58.12ft

Stop Sequence:

#	#	Color	St.	Code	Name	Chart
1.	8		2,586	53	Faded Pink	Wilcom
2.	7		1,458	44	Red Brown	Wilcom
3.	2		616	4	Yellow	Wilcom
4.	6		757	22	Ice Blue	Wilcom
5.	1		313	2		Wilcom
6.	7		317	44	Red Brown	Wilcom
7.	4		694	9		Wilcom
8.	5		172	12		Wilcom
9.	3		539	6	Brick Red	Wilcom

Color Film

Wilcom TrueSizer



Design: **Spyglass**

Title: **Spyglass**

Stitches: 7,454

Height: 1.62 in

Width: 3.81 in

Colors: 8

Colorway: Colorway 1

Zoom: 0.49

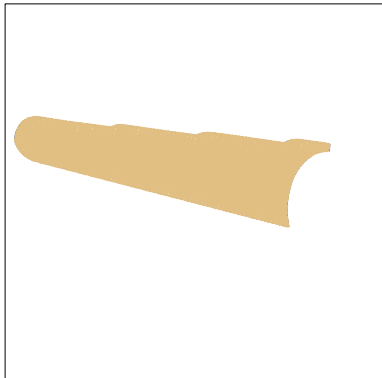

Stop #: 1
Code: 53
Name: Faded Pink
Chart: Wilcom
Stitches: 2,586
Thread used: 53.00ft

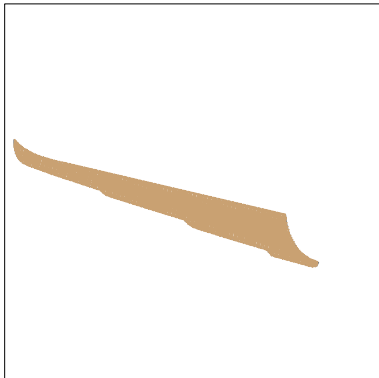

Stop #: 2
Code: 44
Name: Red Brown
Chart: Wilcom
Stitches: 1,458
Thread used: 25.70ft

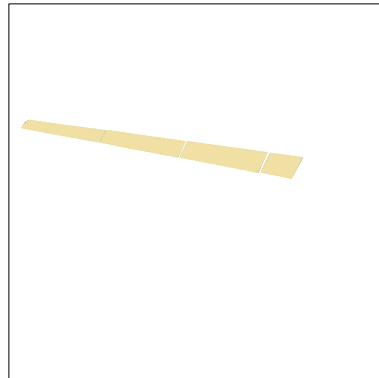

Stop #: 3
Code: 4
Name: Yellow
Chart: Wilcom
Stitches: 616
Thread used: 13.66ft

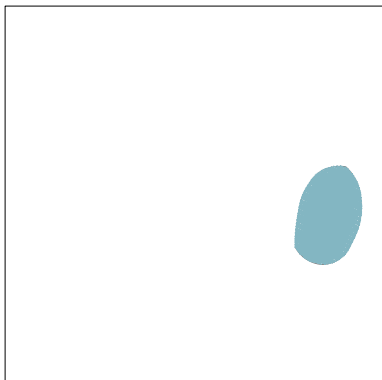

Stop #: 4
Code: 22
Name: Ice Blue
Chart: Wilcom
Stitches: 757
Thread used: 15.07ft

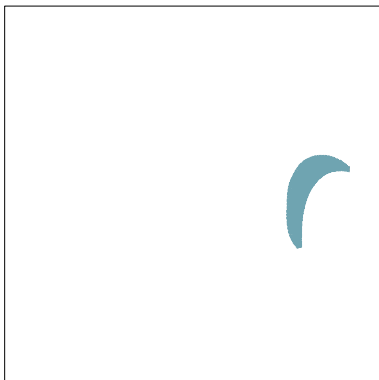

Stop #: 5
Code: 2
Name:
Chart: Wilcom
Stitches: 313
Thread used: 7.21ft



Stop #: 6
Code: 44
Name: Red Brown
Chart: Wilcom
Stitches: 317
Thread used: 5.68ft



Stop #: 7
Code: 9
Name:
Chart: Wilcom
Stitches: 694
Thread used: 14.59ft

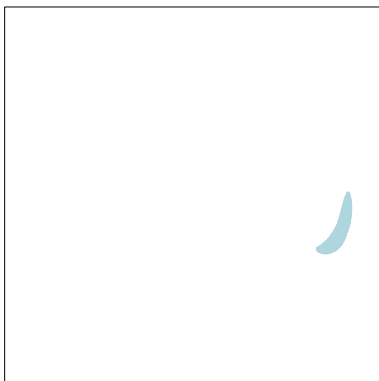

Stop #: 8
Code: 12
Name:
Chart: Wilcom
Stitches: 172
Thread used: 3.15ft

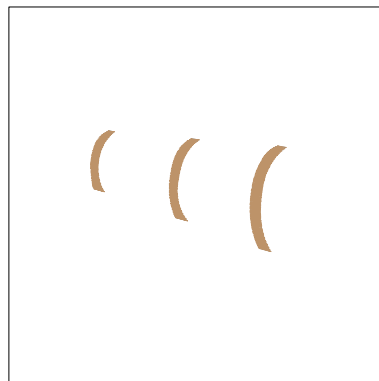

Stop #: 9
Code: 6
Name: Brick Red
Chart: Wilcom
Stitches: 539
Thread used: 8.90ft