

Michaels®

Embroidery Design  
Sewing Information

# Production Worksheet

Wilcom TrueSizer



Design: **Blue Boba Tea**

Title: **Blue Boba Tea**

Stitches: 13,161  
 Height: 3.82 in  
 Width: 2.56 in  
 Colors: 12  
 Colorway: Colorway 1  
 Zoom: 1:1

Machine format: Tajima  
 Color changes: 15  
 Stops: 16  
 Trims: 24  
 Auto fabric: Pure Cotton  
 Required stabilizer: Topping:  
 Backing: Tear Away x  
 2  
 Appliqués: 0  
 Left: 32.5 mm  
 Right: 32.5 mm  
 Up: 48.5 mm  
 Down: 48.5 mm  
 EndX: 0.00 in  
 EndY: 0.00 in  
 Area: 9.78 in<sup>2</sup>  
 Max stitch: 8.8 mm  
 Min stitch: 0.3 mm  
 Max jump: 6.9 mm  
 Total thread: 254.70ft  
 Total bobbin: 96.65ft

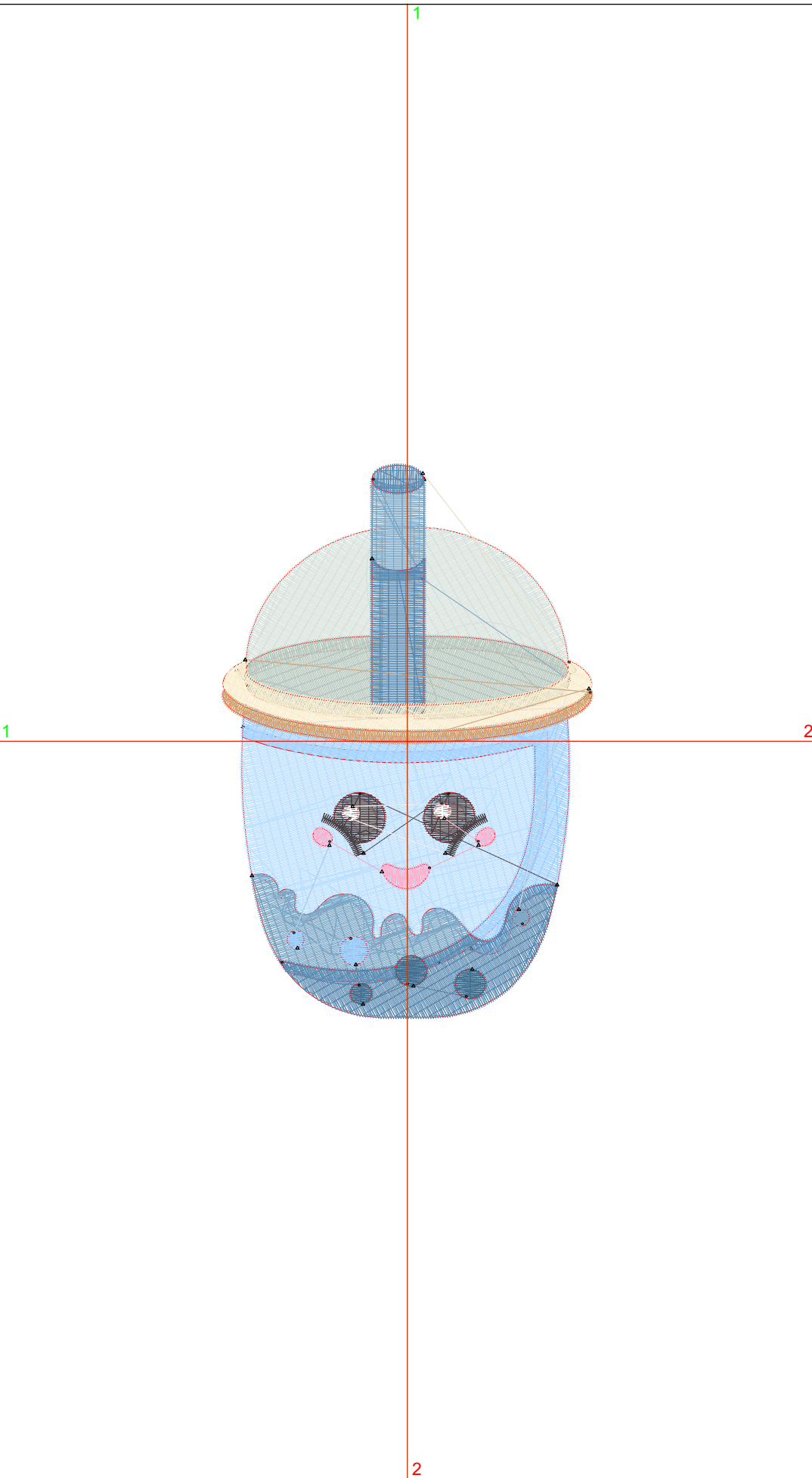

Stop Sequence:

#	#	Color	St.	Code	Name	Chart
1.	4		3,074	4		Wilcom
2.	5		1,336	5		Wilcom
3.	3		1,015	3		Wilcom
4.	7		1,029	7		Wilcom
5.	1		459	1		Wilcom
6.	10		60	15	White	Wilcom
7.	9		158	10		Wilcom
8.	5		88	5		Wilcom
9.	2		147	2		Wilcom
10.	3		33	3		Wilcom
11.	6		1,833	6		Wilcom
12.	8		1,304	8		Wilcom
13.	3		390	3		Wilcom
14.	7		696	7		Wilcom
15.	11		1,043	42		Wilcom
16.	12		494	44		Wilcom

# Color Film

Wilcom TrueSizer



Design: **Blue Boba Tea**

Title: **Blue Boba Tea**

Stitches: 13,161  
Height: 3.82 in  
Width: 2.56 in  
Colors: 12  
Colorway: Colorway 1  
Zoom: 0.49

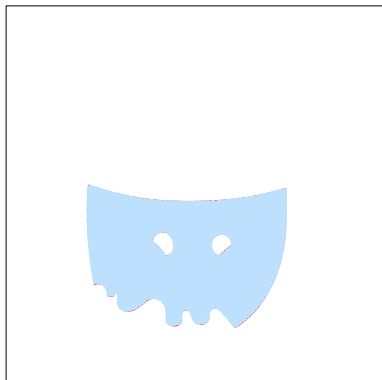

Stop #: 1  
Code: 4  
Name:  
Chart: Wilcom  
Stitches: 3,074  
Thread used: 63.60ft

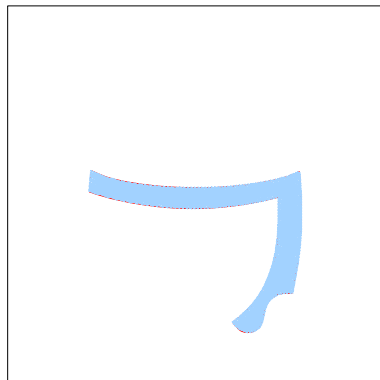

Stop #: 2  
Code: 5  
Name:  
Chart: Wilcom  
Stitches: 1,336  
Thread used: 24.27ft

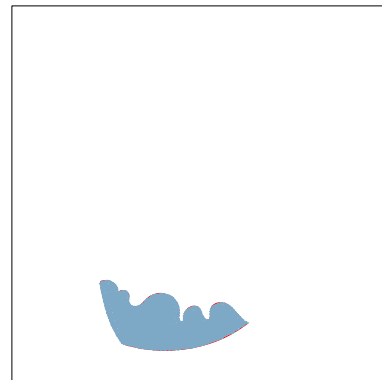

Stop #: 3  
Code: 3  
Name:  
Chart: Wilcom  
Stitches: 1,015  
Thread used: 19.09ft

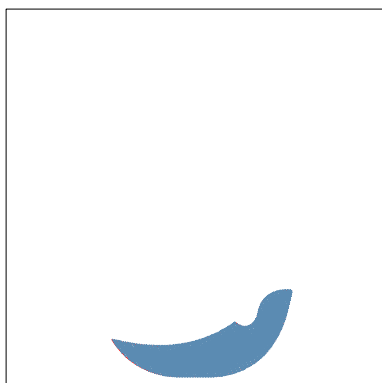

Stop #: 4  
Code: 7  
Name:  
Chart: Wilcom  
Stitches: 1,029  
Thread used: 19.24ft

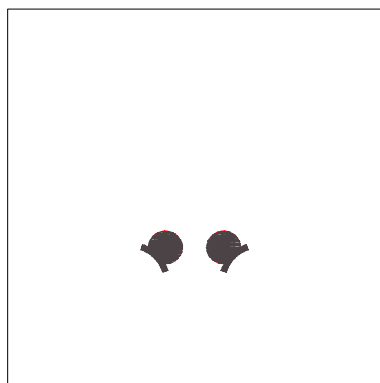

Stop #: 5  
Code: 1  
Name:  
Chart: Wilcom  
Stitches: 459  
Thread used: 7.44ft



Stop #: 6  
Code: 15  
Name: White  
Chart: Wilcom  
Stitches: 60  
Thread used: 0.86ft

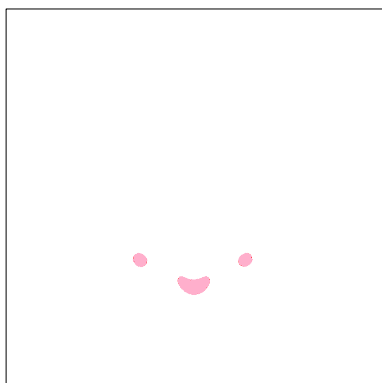

Stop #: 7  
Code: 10  
Name:  
Chart: Wilcom  
Stitches: 158  
Thread used: 2.68ft

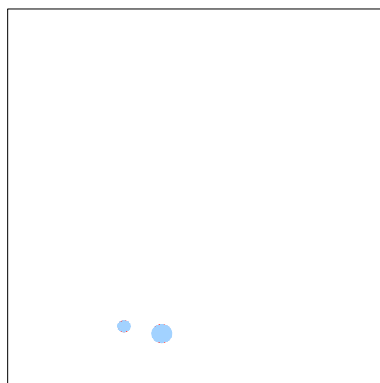

Stop #: 8  
Code: 5  
Name:  
Chart: Wilcom  
Stitches: 88  
Thread used: 1.57ft



Stop #: 9  
Code: 2  
Name:  
Chart: Wilcom  
Stitches: 147  
Thread used: 2.89ft

# Color Film

Wilcom TrueSizer



Design: **Blue Boba Tea**

Title: **Blue Boba Tea**

Stitches: 13,161  
Height: 3.82 in  
Width: 2.56 in  
Colors: 12  
Colorway: Colorway 1  
Zoom: 0.49

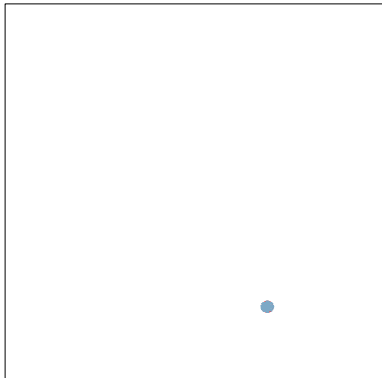

Stop #: 10  
Code: 3  
Name:  
Chart: Wilcom  
Stitches: 33  
Thread used: 0.54ft

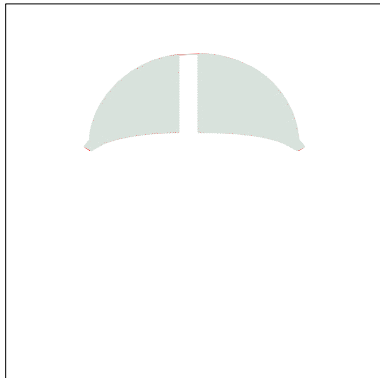

Stop #: 11  
Code: 6  
Name:  
Chart: Wilcom  
Stitches: 1,833  
Thread used: 36.17ft

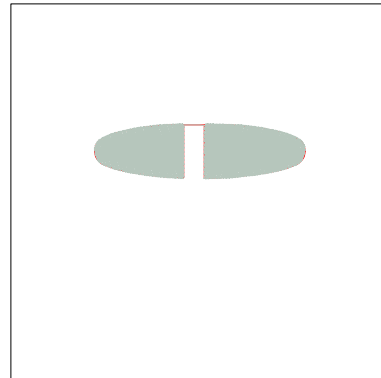

Stop #: 12  
Code: 8  
Name:  
Chart: Wilcom  
Stitches: 1,304  
Thread used: 25.43ft

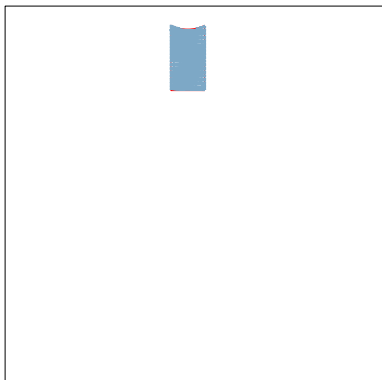

Stop #: 13  
Code: 3  
Name:  
Chart: Wilcom  
Stitches: 390  
Thread used: 7.22ft

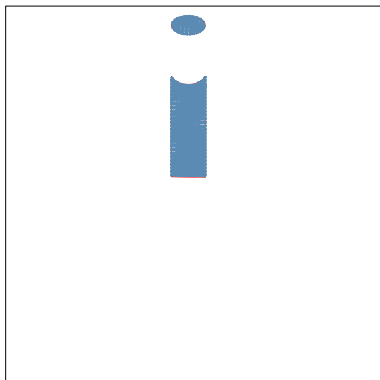

Stop #: 14  
Code: 7  
Name:  
Chart: Wilcom  
Stitches: 696  
Thread used: 12.42ft

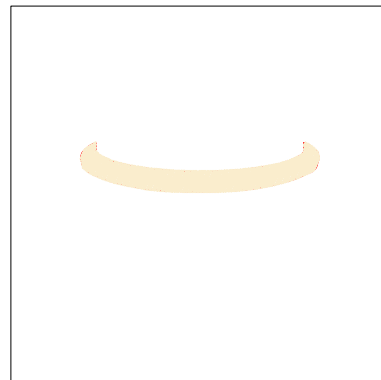

Stop #: 15  
Code: 42  
Name:  
Chart: Wilcom  
Stitches: 1,043  
Thread used: 18.12ft



Stop #: 16  
Code: 44  
Name:  
Chart: Wilcom  
Stitches: 494  
Thread used: 7.92ft