

*Michaels*<sup>®</sup>

**Embroidery Design  
Sewing Information**

# Production Worksheet

Wilcom TrueSizer



Design: **Basic Gray Flashlight**

Title: **Basic Gray Flashlight**

Stitches: 7,364

Height: 1.93 in

Width: 3.81 in

Colors: 13

Colorway: Colorway 1

Zoom: 1:1

Machine format: Tajima  
 Color changes: 12  
 Stops: 13  
 Trims: 15  
 Auto fabric: Pure Cotton  
 Required stabilizer: Topping:  
 Backing: Tear Away x  
 2  
 Appliqués: 0  
 Left: 48.4 mm  
 Right: 48.4 mm  
 Up: 24.5 mm  
 Down: 24.5 mm  
 EndX: 0.00 in  
 EndY: 0.00 in  
 Area 7.36 in<sup>2</sup>  
 Max stitch: 10.8 mm  
 Min stitch: 0.2 mm  
 Max jump: 7.0 mm  
 Total thread: 134.92ft  
 Total bobbin: 48.79ft

Stop Sequence:

#	#	Color	St.	Code	Name	Chart
1.	7	■	1,770	11		Wilcom
2.	12	■	387	13		Wilcom
3.	1	■	475	1		Wilcom
4.	13	■	98	14		Wilcom
5.	5	■	1,361	9		Wilcom
6.	10	□	570	15	White	Wilcom
7.	6	■	142	10		Wilcom
8.	8	■	208	12		Wilcom
9.	2	■	450	2		Wilcom
10.	3	■	556	3		Wilcom
11.	4	■	54	4		Wilcom
12.	9	■	980	13	Black	Wilcom
13.	11	■	311	20		Wilcom

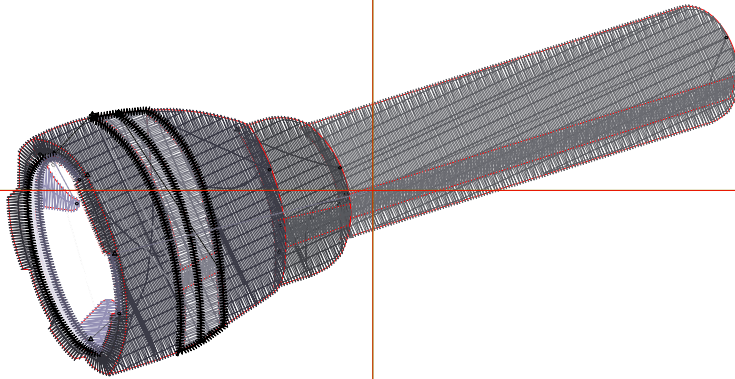

# Color Film

Wilcom TrueSizer



Design: **Basic Gray Flashlight**

Title: **Basic Gray Flashlight**

Stitches: 7,364  
Height: 1.93 in  
Width: 3.81 in  
Colors: 13  
Colorway: Colorway 1  
Zoom: 0.49

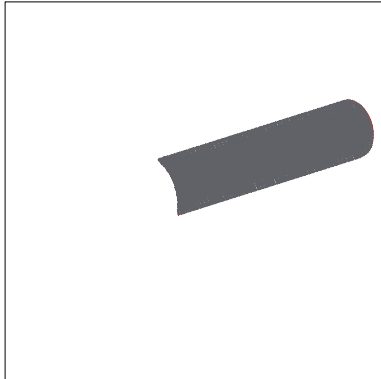

Stop #: 1  
Code: 11  
Name:  
Chart: Wilcom  
Stitches: 1,770  
Thread used: 35.90ft

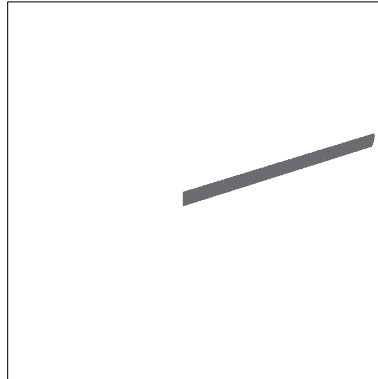

Stop #: 2  
Code: 13  
Name:  
Chart: Wilcom  
Stitches: 387  
Thread used: 7.83ft

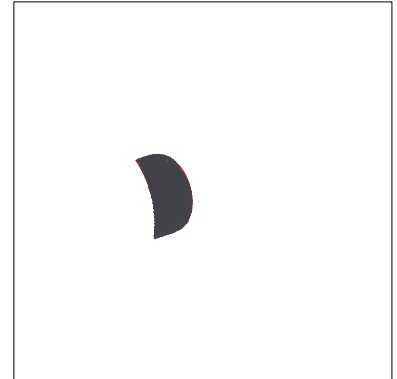

Stop #: 3  
Code: 1  
Name:  
Chart: Wilcom  
Stitches: 475  
Thread used: 9.21ft

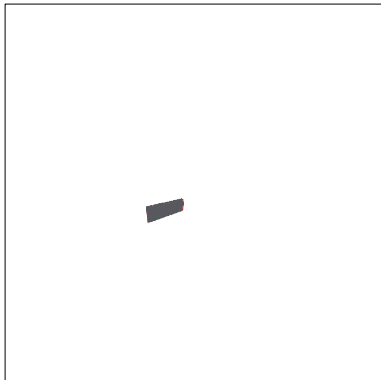

Stop #: 4  
Code: 14  
Name:  
Chart: Wilcom  
Stitches: 98  
Thread used: 1.90ft

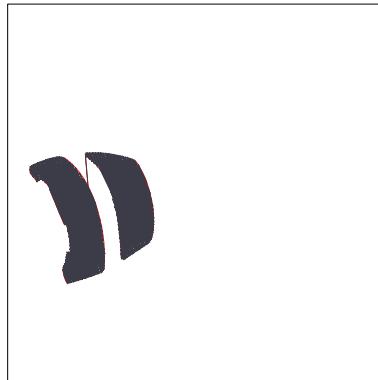

Stop #: 5  
Code: 9  
Name:  
Chart: Wilcom  
Stitches: 1,361  
Thread used: 26.99ft



Stop #: 6  
Code: 15  
Name: White  
Chart: Wilcom  
Stitches: 570  
Thread used: 10.65ft

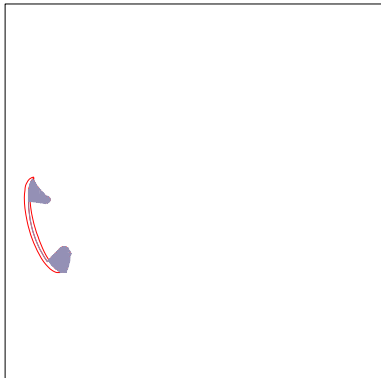

Stop #: 7  
Code: 10  
Name:  
Chart: Wilcom  
Stitches: 142  
Thread used: 2.71ft

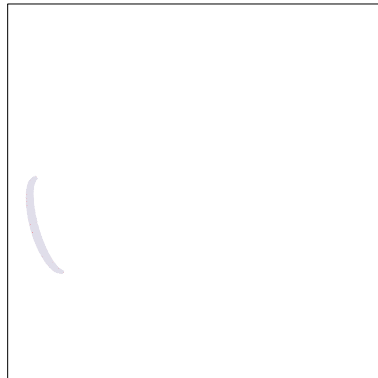

Stop #: 8  
Code: 12  
Name:  
Chart: Wilcom  
Stitches: 208  
Thread used: 3.04ft

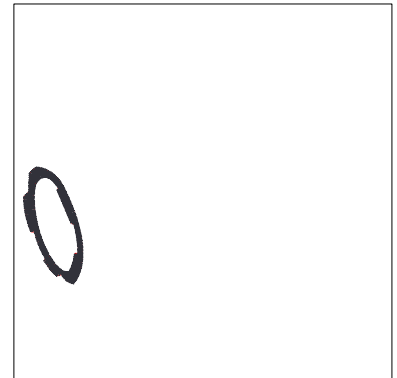

Stop #: 9  
Code: 2  
Name:  
Chart: Wilcom  
Stitches: 450  
Thread used: 7.07ft

# Color Film

Wilcom TrueSizer



Design: **Basic Gray Flashlight**

Title: **Basic Gray Flashlight**

Stitches: 7,364  
Height: 1.93 in  
Width: 3.81 in  
Colors: 13  
Colorway: Colorway 1  
Zoom: 0.49

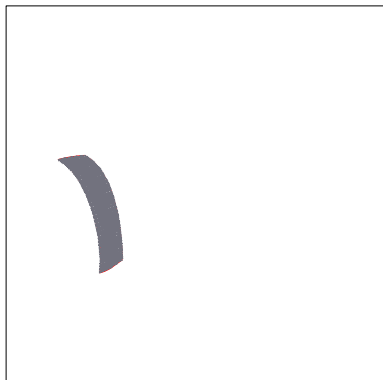

Stop #: 10  
Code: 3  
Name:  
Chart: Wilcom  
Stitches: 556  
Thread used: 9.61ft

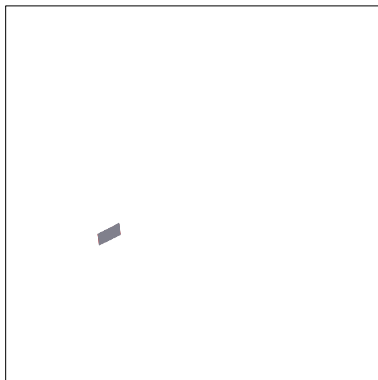

Stop #: 11  
Code: 4  
Name:  
Chart: Wilcom  
Stitches: 54  
Thread used: 0.99ft

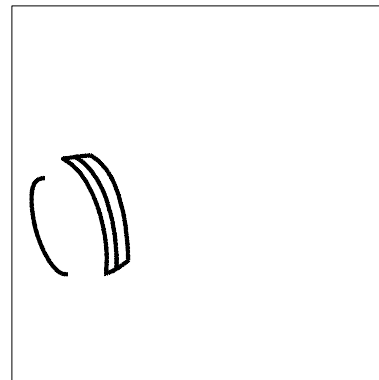

Stop #: 12  
Code: 13  
Name: Black  
Chart: Wilcom  
Stitches: 980  
Thread used: 11.21ft

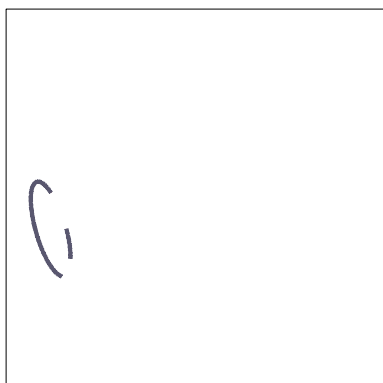

Stop #: 13  
Code: 20  
Name:  
Chart: Wilcom  
Stitches: 311  
Thread used: 3.55ft