

Michaels®

Embroidery Design
Sewing Information

Production Worksheet

Wilcom TrueSizer



Design: **Green Binocular**
 Title: **Green Binocular**

Stitches: 13,649
 Height: 2.29 in
 Width: 3.82 in
 Colors: 13
 Colorway: Colorway 1
 Zoom: 1:1

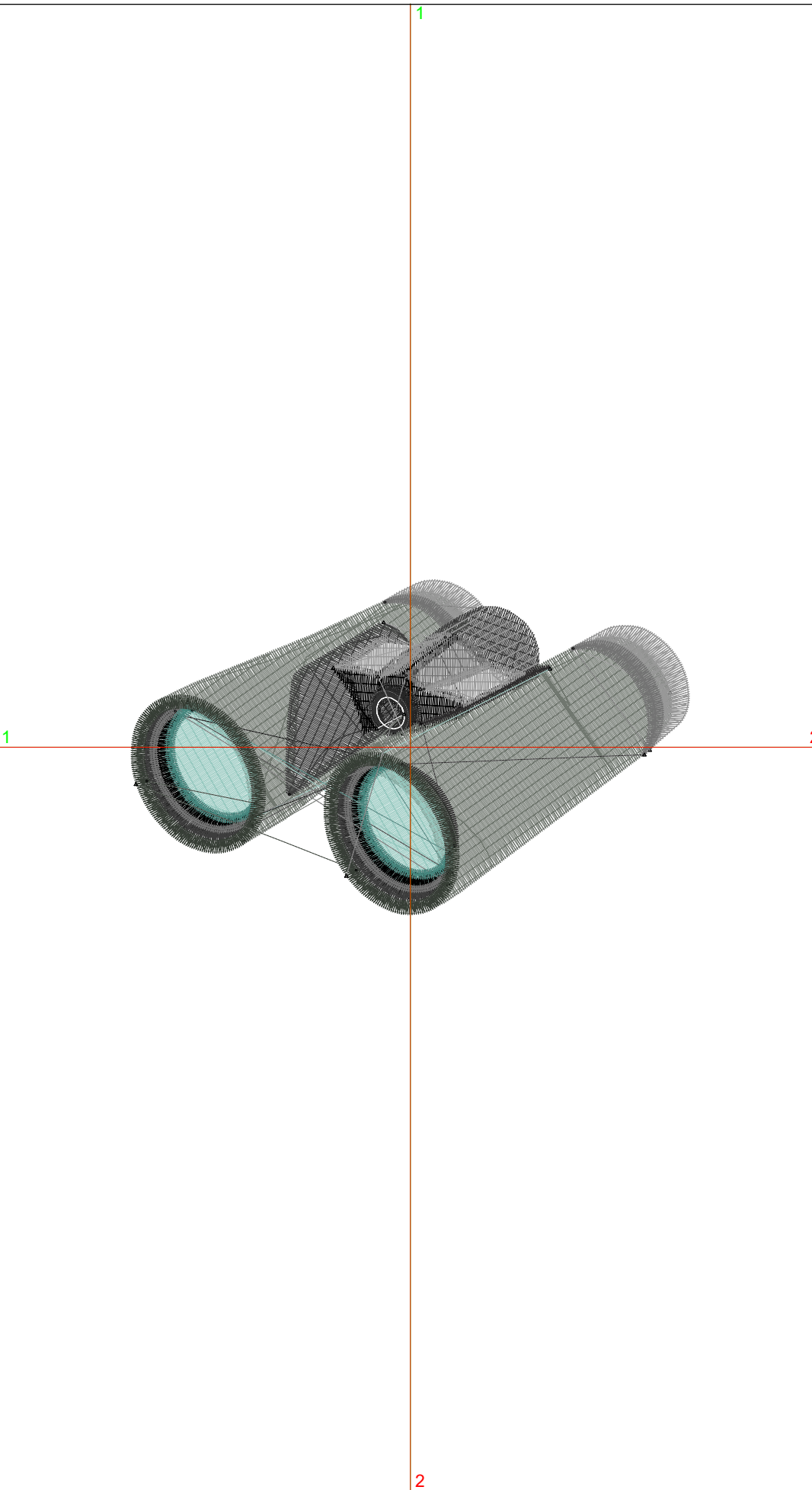

Machine format: Tajima
 Color changes: 21
 Stops: 22
 Trims: 32
 Auto fabric: Pure Cotton
 Required stabilizer: Topping:
 Backing: Tear Away x
 2
 Appliqués: 0
 Left: 48.5 mm
 Right: 48.5 mm
 Up: 29.1 mm
 Down: 29.1 mm
 EndX: 0.00 in
 EndY: 0.00 in
 Area 8.74 in²
 Max stitch: 12.0 mm
 Min stitch: 0.2 mm
 Max jump: 7.0 mm
 Total thread: 244.21ft
 Total bobbin: 87.37ft

Stop Sequence:

#	#	Color	St.	Code	Name	Chart
1.	8	■	1,628	13		Wilcom
2.	7	■	240	12		Wilcom
3.	6	■	112	11		Wilcom
4.	13	■	1,121	19		Wilcom
5.	7	■	186	12		Wilcom
6.	4	■	580	13	Black	Wilcom
7.	12	■	115	17		Wilcom
8.	11	■	131	16		Wilcom
9.	9	■	166	14		Wilcom
10.	10	□	44	15	White	Wilcom
11.	8	■	2,331	13		Wilcom
12.	7	■	505	12		Wilcom
13.	6	■	230	11		Wilcom
14.	3	■	333	8		Wilcom
15.	5	■	1,163	10		Wilcom
16.	4	■	1,137	13	Black	Wilcom
17.	13	■	660	19		Wilcom
18.	6	■	531	11		Wilcom
19.	2	■	512	6		Wilcom
20.	1	■	1,108	5		Wilcom
21.	6	■	243	11		Wilcom
22.	7	■	571	12		Wilcom

Color Film

Wilcom TrueSizer



Design: **Green Binocular**

Title: **Green Binocular**

Stitches: 13,649
Height: 2.29 in
Width: 3.82 in
Colors: 13
Colorway: Colorway 1
Zoom: 0.49

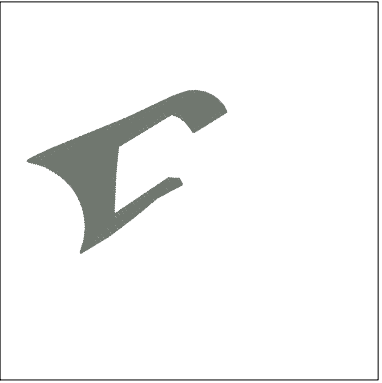

Stop #: 1
Code: 13
Name:
Chart: Wilcom
Stitches: 1,628
Thread used: 29.40ft

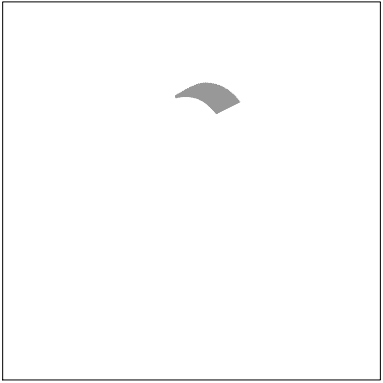

Stop #: 2
Code: 12
Name:
Chart: Wilcom
Stitches: 240
Thread used: 4.06ft

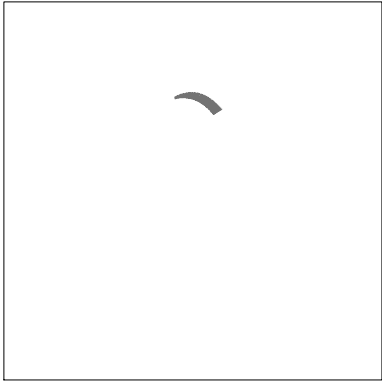

Stop #: 3
Code: 11
Name:
Chart: Wilcom
Stitches: 112
Thread used: 1.62ft

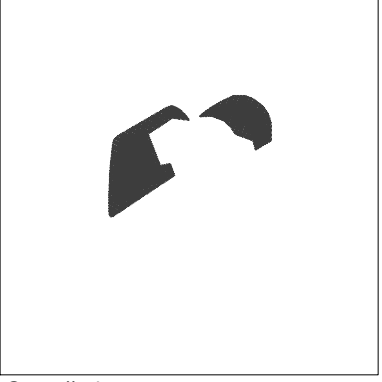

Stop #: 4
Code: 19
Name:
Chart: Wilcom
Stitches: 1,121
Thread used: 20.01ft

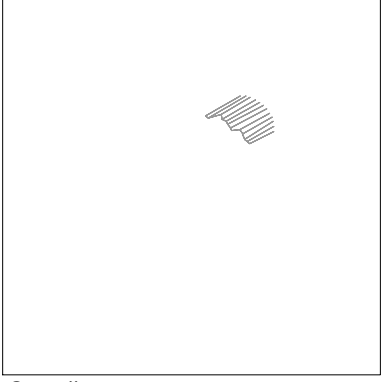

Stop #: 5
Code: 12
Name:
Chart: Wilcom
Stitches: 186
Thread used: 2.48ft

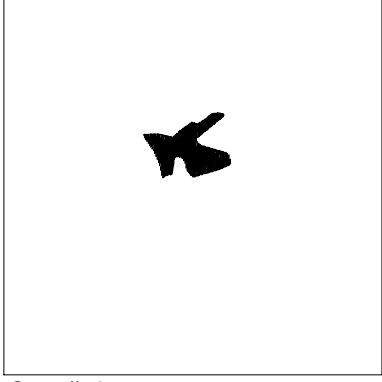

Stop #: 6
Code: 13
Name: Black
Chart: Wilcom
Stitches: 580
Thread used: 9.72ft

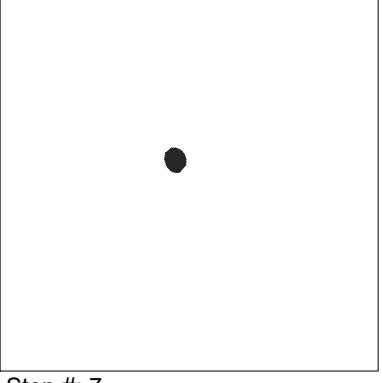

Stop #: 7
Code: 17
Name:
Chart: Wilcom
Stitches: 115
Thread used: 1.79ft

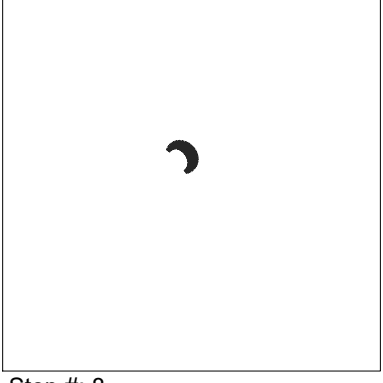

Stop #: 8
Code: 16
Name:
Chart: Wilcom
Stitches: 131
Thread used: 2.11ft

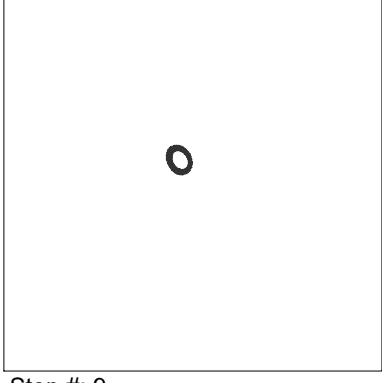

Stop #: 9
Code: 14
Name:
Chart: Wilcom
Stitches: 166
Thread used: 2.08ft

Color Film

Wilcom TrueSizer



Design: **Green Binocular**

Title: **Green Binocular**

Stitches: 13,649
Height: 2.29 in
Width: 3.82 in
Colors: 13
Colorway: Colorway 1
Zoom: 0.49

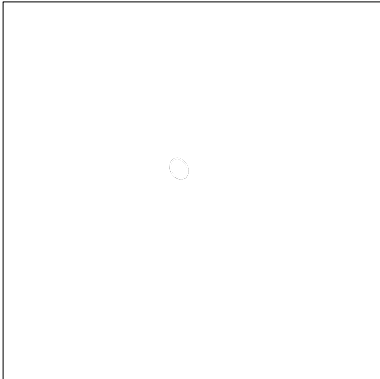

Stop #: 10
Code: 15
Name: White
Chart: Wilcom
Stitches: 44
Thread used: 0.48ft

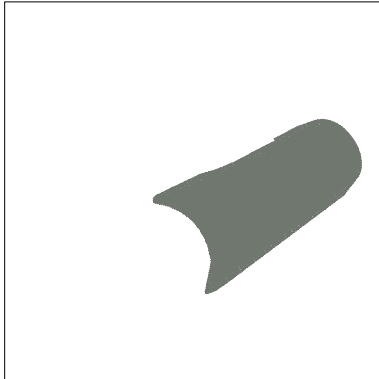

Stop #: 11
Code: 13
Name:
Chart: Wilcom
Stitches: 2,331
Thread used: 48.90ft

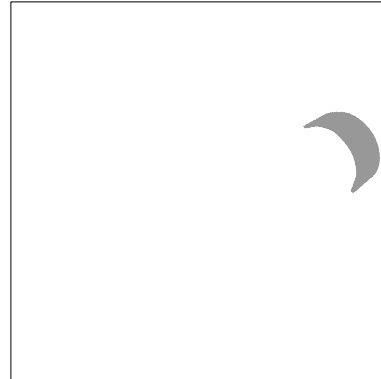

Stop #: 12
Code: 12
Name:
Chart: Wilcom
Stitches: 505
Thread used: 8.72ft

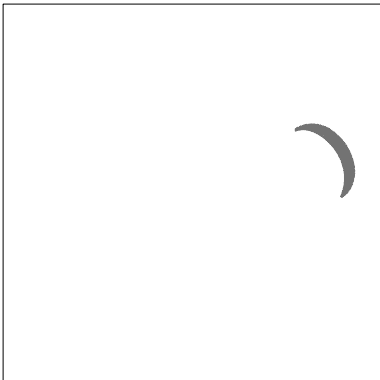

Stop #: 13
Code: 11
Name:
Chart: Wilcom
Stitches: 230
Thread used: 3.87ft

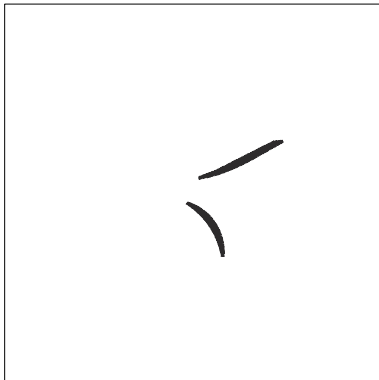

Stop #: 14
Code: 8
Name:
Chart: Wilcom
Stitches: 333
Thread used: 4.46ft

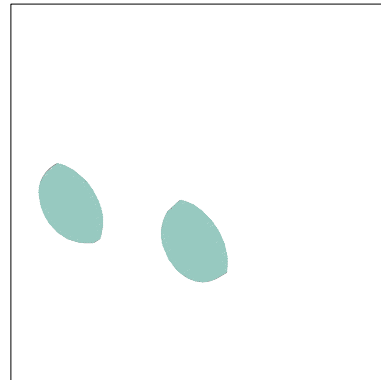

Stop #: 15
Code: 10
Name:
Chart: Wilcom
Stitches: 1,163
Thread used: 22.48ft

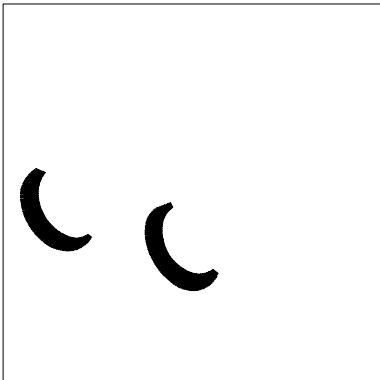

Stop #: 16
Code: 13
Name: Black
Chart: Wilcom
Stitches: 1,137
Thread used: 17.30ft

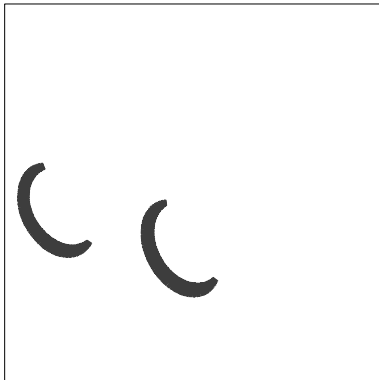

Stop #: 17
Code: 19
Name:
Chart: Wilcom
Stitches: 660
Thread used: 13.09ft

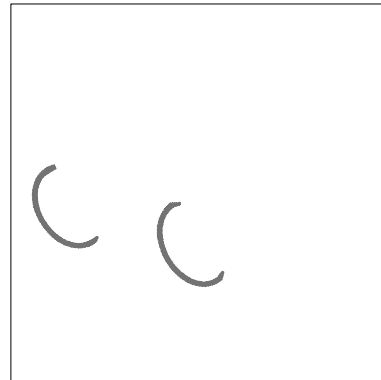

Stop #: 18
Code: 11
Name:
Chart: Wilcom
Stitches: 531
Thread used: 6.73ft

Color Film

Wilcom TrueSizer



Design: **Green Binocular**

Title: **Green Binocular**

Stitches: 13,649
Height: 2.29 in
Width: 3.82 in
Colors: 13
Colorway: Colorway 1
Zoom: 0.49

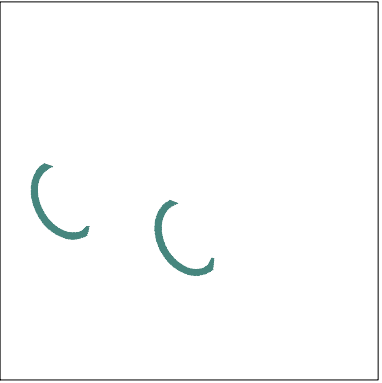

Stop #: 19
Code: 6
Name:
Chart: Wilcom
Stitches: 512
Thread used: 7.05ft

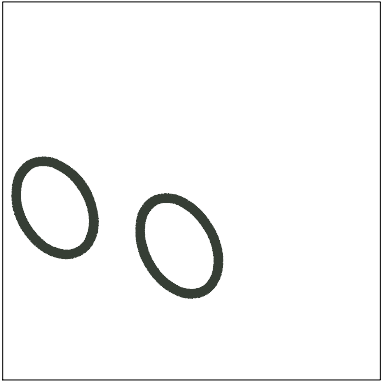

Stop #: 20
Code: 5
Name:
Chart: Wilcom
Stitches: 1,108
Thread used: 18.29ft

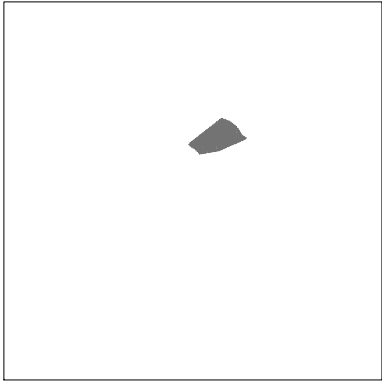

Stop #: 21
Code: 11
Name:
Chart: Wilcom
Stitches: 243
Thread used: 3.89ft

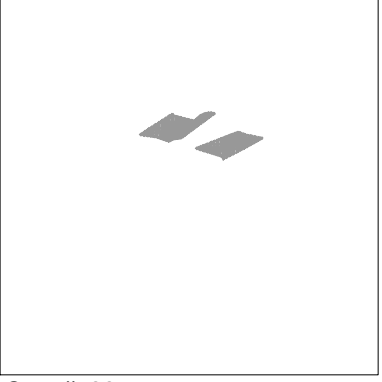

Stop #: 22
Code: 12
Name:
Chart: Wilcom
Stitches: 571
Thread used: 8.45ft