

Michaels®

Embroidery Design
Sewing Information

Production Worksheet

Wilcom TrueSizer



Design: **Wooden Sleigh**

Title: **Wooden Sleigh**

Stitches: 7,289
 Height: 1.70 in
 Width: 3.80 in
 Colors: 11
 Colorway: Madeira Classic 40
 Zoom: 1:1

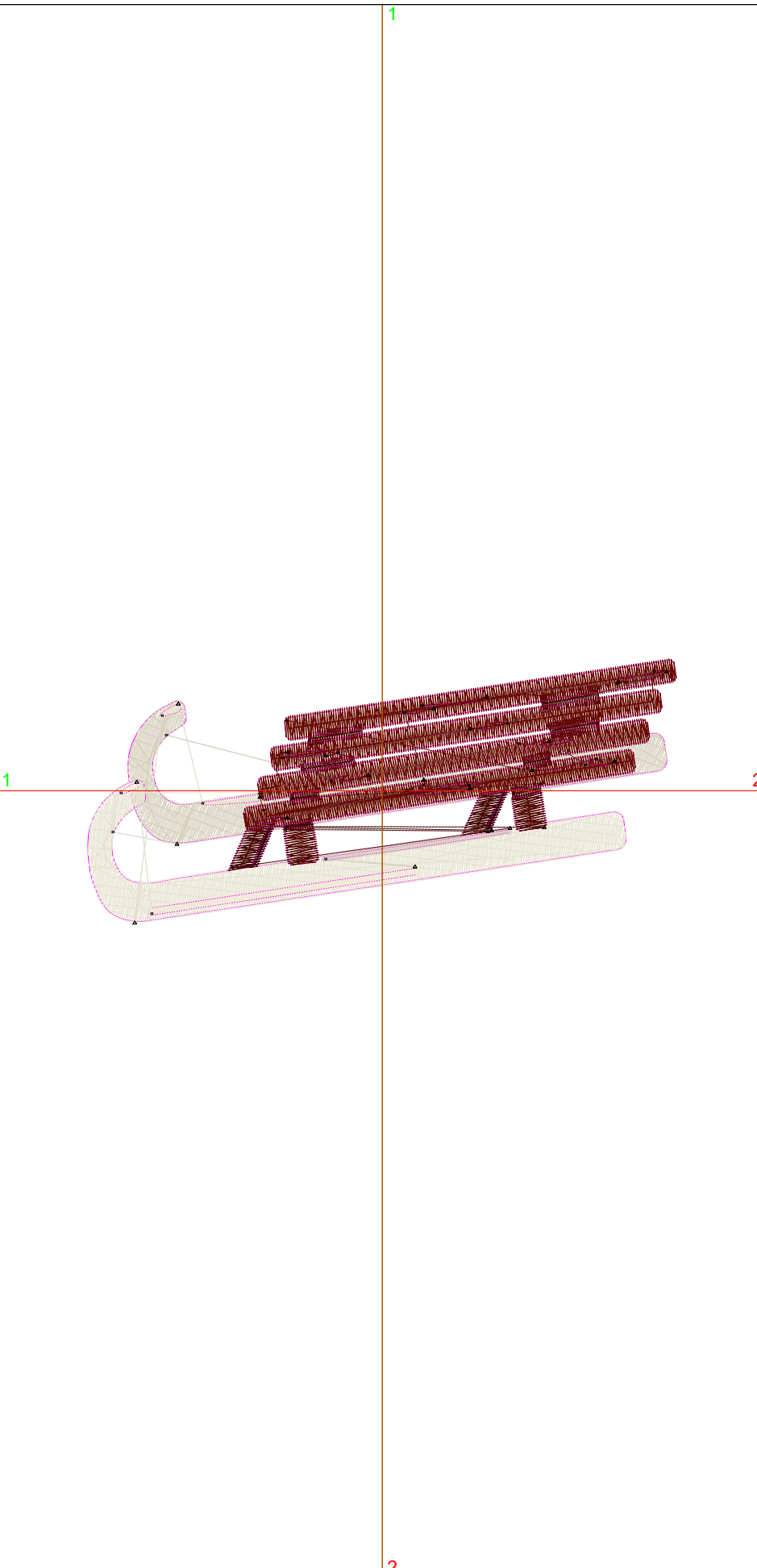

Machine format: Tajima
 Color changes: 11
 Stops: 12
 Trims: 28
 Auto fabric: Pure Cotton
 Required stabilizer: Topping:
 Backing: Tear Away x 2
 Appliqués: 0
 Left: 48.3 mm
 Right: 48.3 mm
 Up: 21.6 mm
 Down: 21.6 mm
 EndX: 0.00 in
 EndY: 0.00 in
 Area: 6.48 in²
 Max stitch: 11.0 mm
 Min stitch: 0.3 mm
 Max jump: 6.8 mm
 Total thread: 133.38ft
 Total bobbin: 48.36ft

Stop Sequence:

#	#	Color	St.	Code	Name	Chart
1.	3	█	1,647	1146	Madeira Classic 40	
2.	4	█	1,645	1064	Madeira Classic 40	
3.	5	█	110	1094	Madeira Classic 40	
4.	6	█	36	1309	Madeira Classic 40	
5.	7	█	291	1249	Madeira Classic 40	
6.	8	█	204	1134	Madeira Classic 40	
7.	15	█	156	1321	Madeira Classic 40	
8.	2	█	149	1934	Madeira Classic	
9.	10	█	128	1172	Madeira Classic 40	
10.	11	█	468	1033	Madeira Classic 40	
11.	1	█	2,216	1103	Madeira Classic 40	
12.	2	█	237	1934	Madeira Classic	

Color Film

Wilcom TrueSizer



Design: **Wooden Sleigh**

Title: **Wooden Sleigh**

Stitches: 7,289
Height: 1.70 in
Width: 3.80 in
Colors: 11
Colorway: Madeira Classic 40
Zoom: 0.49

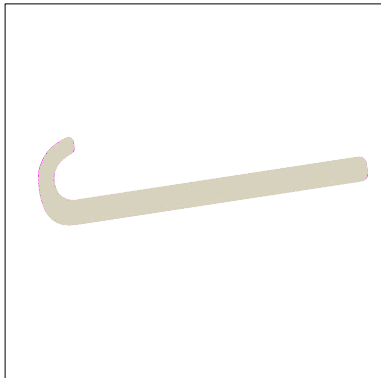

Stop #: 1
Code: 1146
Name:
Chart: Madeira Classic 40
Stitches: 1,647
Thread used: 29.31ft

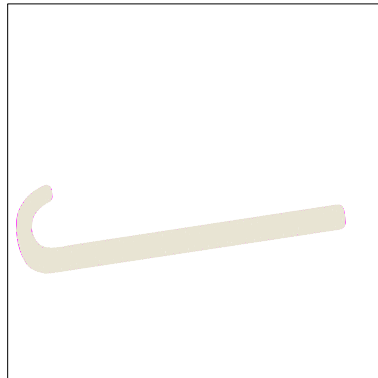

Stop #: 2
Code: 1064
Name:
Chart: Madeira Classic 40
Stitches: 1,645
Thread used: 29.10ft

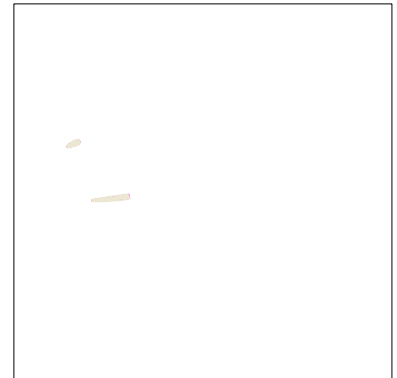

Stop #: 3
Code: 1094
Name:
Chart: Madeira Classic 40
Stitches: 110
Thread used: 1.37ft

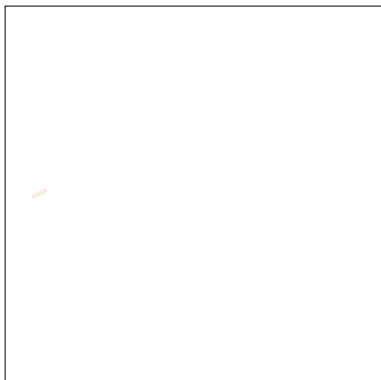

Stop #: 4
Code: 1309
Name:
Chart: Madeira Classic 40
Stitches: 36
Thread used: 0.42ft

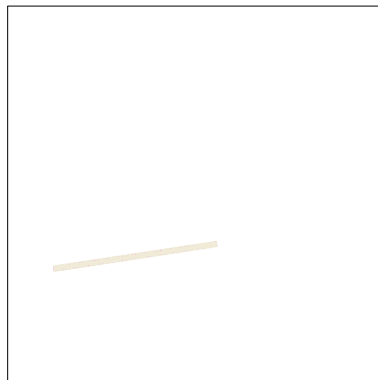

Stop #: 5
Code: 1249
Name:
Chart: Madeira Classic 40
Stitches: 291
Thread used: 3.93ft

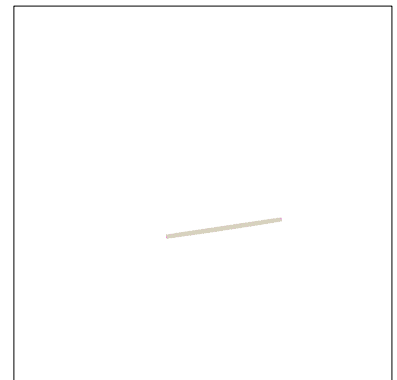

Stop #: 6
Code: 1134
Name:
Chart: Madeira Classic 40
Stitches: 204
Thread used: 2.42ft

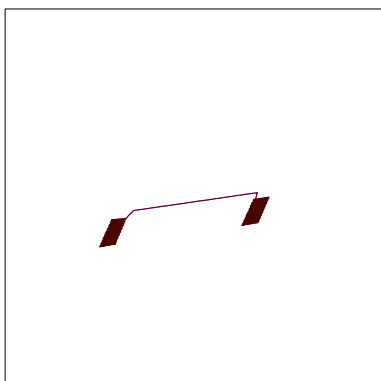

Stop #: 7
Code: 1321
Name:
Chart: Madeira Classic 40
Stitches: 156
Thread used: 2.99ft

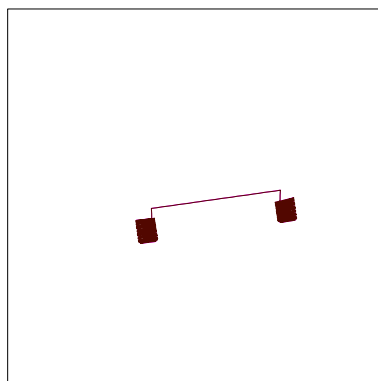

Stop #: 8
Code: 1934
Name:
Chart: Madeira Classic
Stitches: 149
Thread used: 3.15ft

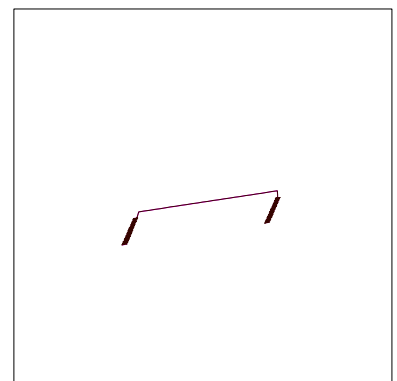

Stop #: 9
Code: 1172
Name:
Chart: Madeira Classic 40
Stitches: 128
Thread used: 1.60ft

Color Film

Wilcom TrueSizer



Design: **Wooden Sleigh**

Title: **Wooden Sleigh**

Stitches: 7,289
Height: 1.70 in
Width: 3.80 in
Colors: 11
Colorway: Madeira Classic 40
Zoom: 0.49

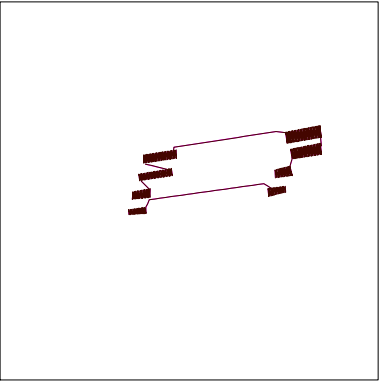

Stop #: 10
Code: 1033
Name:
Chart: Madeira Classic 40
Stitches: 468
Thread used: 7.07ft

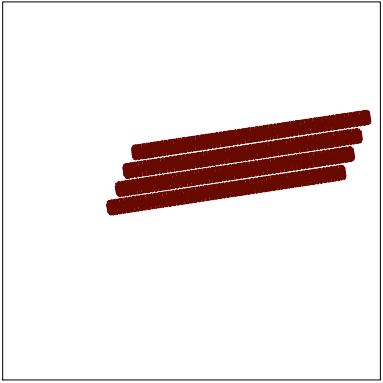

Stop #: 11
Code: 1103
Name:
Chart: Madeira Classic 40
Stitches: 2,216
Thread used: 45.51ft

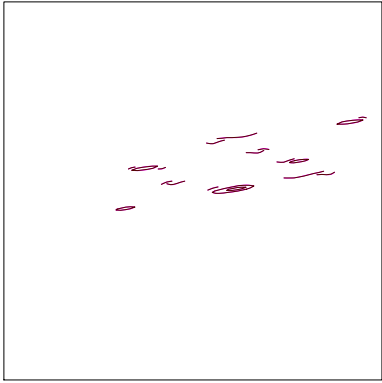

Stop #: 12
Code: 1934
Name:
Chart: Madeira Classic
Stitches: 237
Thread used: 2.56ft