

Michaels®

Embroidery Design  
Sewing Information

# Production Worksheet

Wilcom TrueSizer



Stitches: 6,009  
 Height: 3.81 in  
 Width: 3.47 in  
 Colors: 7  
 Colorway: Colorway 1  
 Zoom: 1:1

Design: **Gray and Red Telescope**

Title: **Gray and Red Telescope**

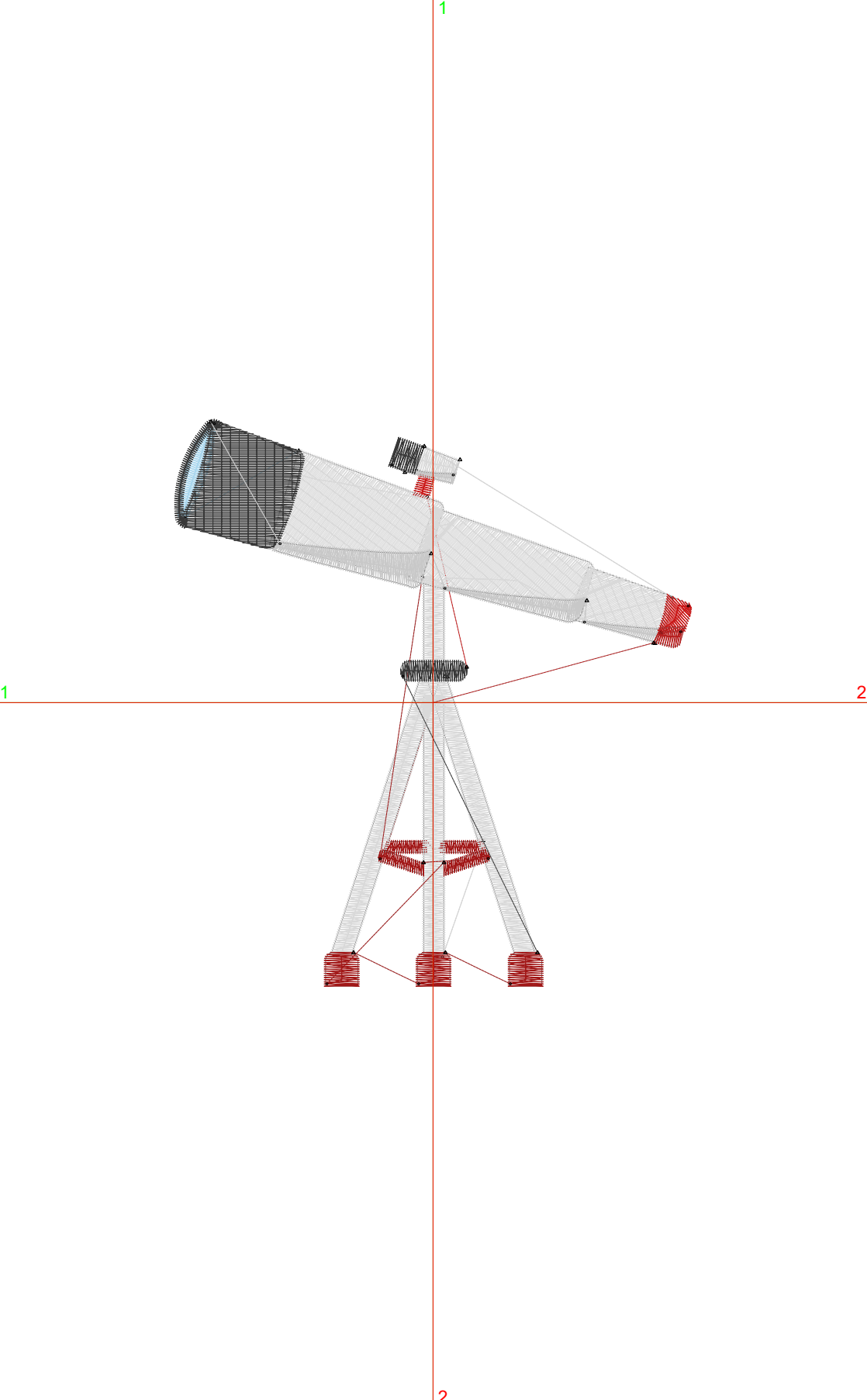

Machine format: Tajima  
 Color changes: 13  
 Stops: 14  
 Trims: 22  
 Auto fabric: Pure Cotton  
 Required stabilizer: Topping:  
 Backing: Tear Away x  
 2  
 Appliqués: 0  
 Left: 44.1 mm  
 Right: 44.1 mm  
 Up: 48.4 mm  
 Down: 48.4 mm  
 EndX: 0.00 in  
 EndY: 0.00 in  
 Area: 13.24 in<sup>2</sup>  
 Max stitch: 6.9 mm  
 Min stitch: 0.4 mm  
 Max jump: 6.9 mm  
 Total thread: 115.28ft  
 Total bobbin: 42.23ft

Stop Sequence:

#	#	Color	St.	Code	Name	Chart
1.	3	■	135	3	Wilcom	
2.	1	■	1,346	1	Wilcom	
3.	3	■	358	3	Wilcom	
4.	6	■	101	6	Wilcom	
5.	5	■	46	5	Wilcom	
6.	1	■	108	1	Wilcom	
7.	10	■	71	10	Wilcom	
8.	6	■	90	6	Wilcom	
9.	1	■	1,936	1	Wilcom	
10.	8	■	128	8	Wilcom	
11.	6	■	778	6	Wilcom	
12.	10	■	796	10	Wilcom	
13.	5	■	66	5	Wilcom	
14.	4	■	48	4	Wilcom	

# Color Film

Wilcom TrueSizer



Stitches: 6,009  
Height: 3.81 in  
Width: 3.47 in  
Colors: 7  
Colorway: Colorway 1  
Zoom: 0.49

Design: **Gray and Red Telescope**

Title: **Gray and Red Telescope**

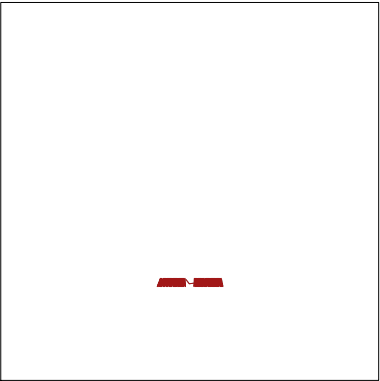

Stop #: 1  
Code: 3  
Name:  
Chart: Wilcom  
Stitches: 135  
Thread used: 2.08ft

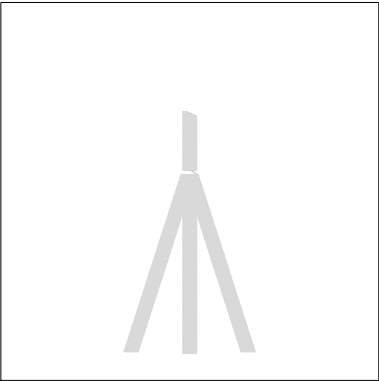

Stop #: 2  
Code: 1  
Name:  
Chart: Wilcom  
Stitches: 1,346  
Thread used: 27.34ft

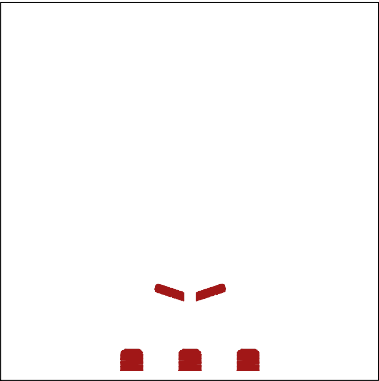

Stop #: 3  
Code: 3  
Name:  
Chart: Wilcom  
Stitches: 358  
Thread used: 6.98ft

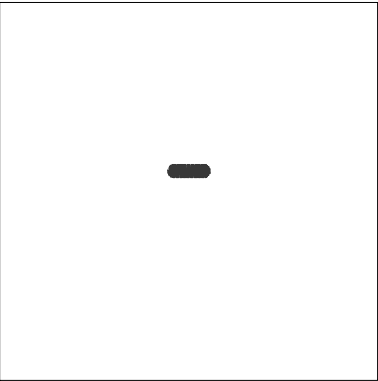

Stop #: 4  
Code: 6  
Name:  
Chart: Wilcom  
Stitches: 101  
Thread used: 1.91ft

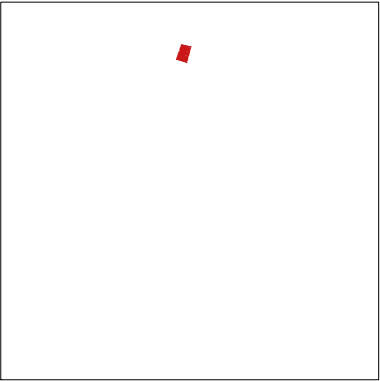

Stop #: 5  
Code: 5  
Name:  
Chart: Wilcom  
Stitches: 46  
Thread used: 0.70ft

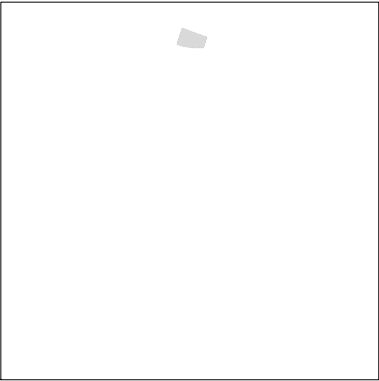

Stop #: 6  
Code: 1  
Name:  
Chart: Wilcom  
Stitches: 108  
Thread used: 1.60ft

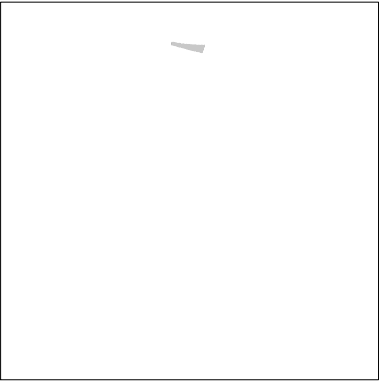

Stop #: 7  
Code: 10  
Name:  
Chart: Wilcom  
Stitches: 71  
Thread used: 0.88ft

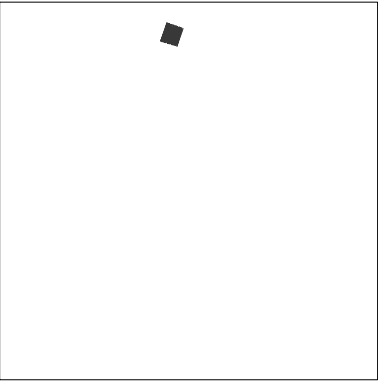

Stop #: 8  
Code: 6  
Name:  
Chart: Wilcom  
Stitches: 90  
Thread used: 1.40ft

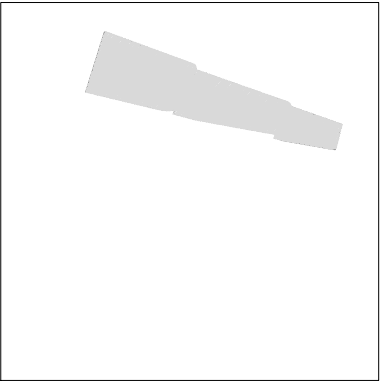

Stop #: 9  
Code: 1  
Name:  
Chart: Wilcom  
Stitches: 1,936  
Thread used: 37.53ft

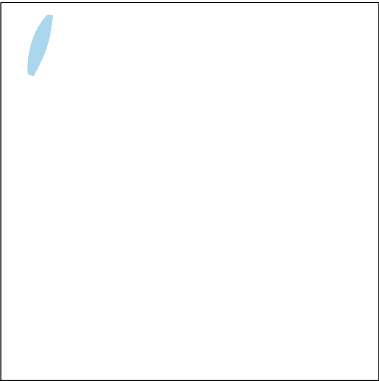

Stop #: 10  
Code: 8  
Name:  
Chart: Wilcom  
Stitches: 128  
Thread used: 2.40ft

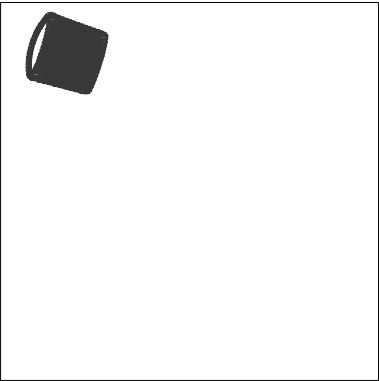

Stop #: 11  
Code: 6  
Name:  
Chart: Wilcom  
Stitches: 778  
Thread used: 14.54ft

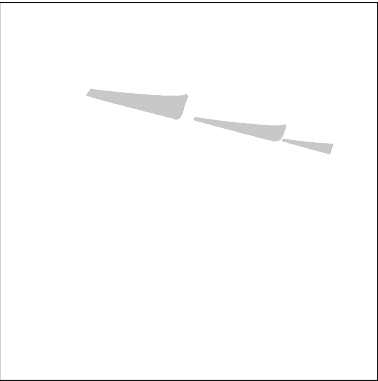

Stop #: 12  
Code: 10  
Name:  
Chart: Wilcom  
Stitches: 796  
Thread used: 11.31ft

**Color Film**

Wilcom TrueSizer



Stitches: 6,009  
Height: 3.81 in  
Width: 3.47 in  
Colors: 7  
Colorway: Colorway 1  
Zoom: 0.49

Design: **Gray and Red Telescope**

Title: **Gray and Red Telescope**

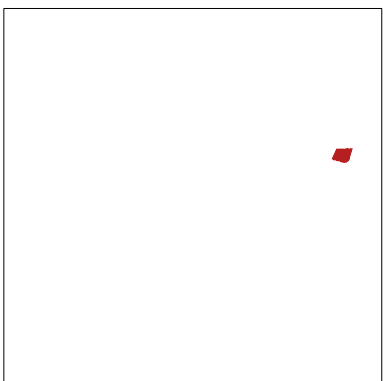
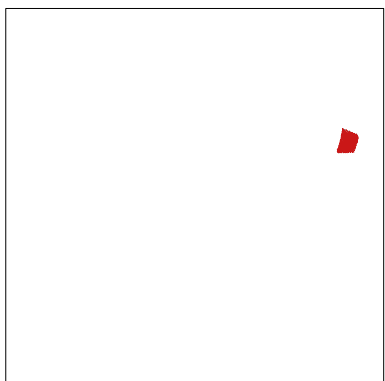

Stop #: 13  
Code: 5  
Name:  
Chart: Wilcom  
Stitches: 66  
Thread used: 1.23ft

Stop #: 14  
Code: 4  
Name:  
Chart: Wilcom  
Stitches: 48  
Thread used: 0.78ft