

Michaels®

Embroidery Design
Sewing Information

Production Worksheet

Wilcom TrueSizer



Design: **Carnival Drum**

Title: **Carnival Drum**

Stitches: 13,457
 Height: 3.82 in
 Width: 2.71 in
 Colors: 7
 Colorway: Colorway 1
 Zoom: 1:1

Machine format: Tajima
 Color changes: 8
 Stops: 9
 Trims: 13
 Auto fabric: Pure Cotton
 Required stabilizer: Topping:
 Backing: Tear Away
 x 2
 Appliqués: 0
 Left: 34.4 mm
 Right: 34.4 mm
 Up: 48.5 mm
 Down: 48.5 mm
 EndX: 0.00 in
 EndY: 0.00 in
 Area: 10.34 in²
 Max stitch: 10.3 mm
 Min stitch: 0.3 mm
 Max jump: 6.6 mm
 Total thread: 246.52ft
 Total bobbin: 92.01ft

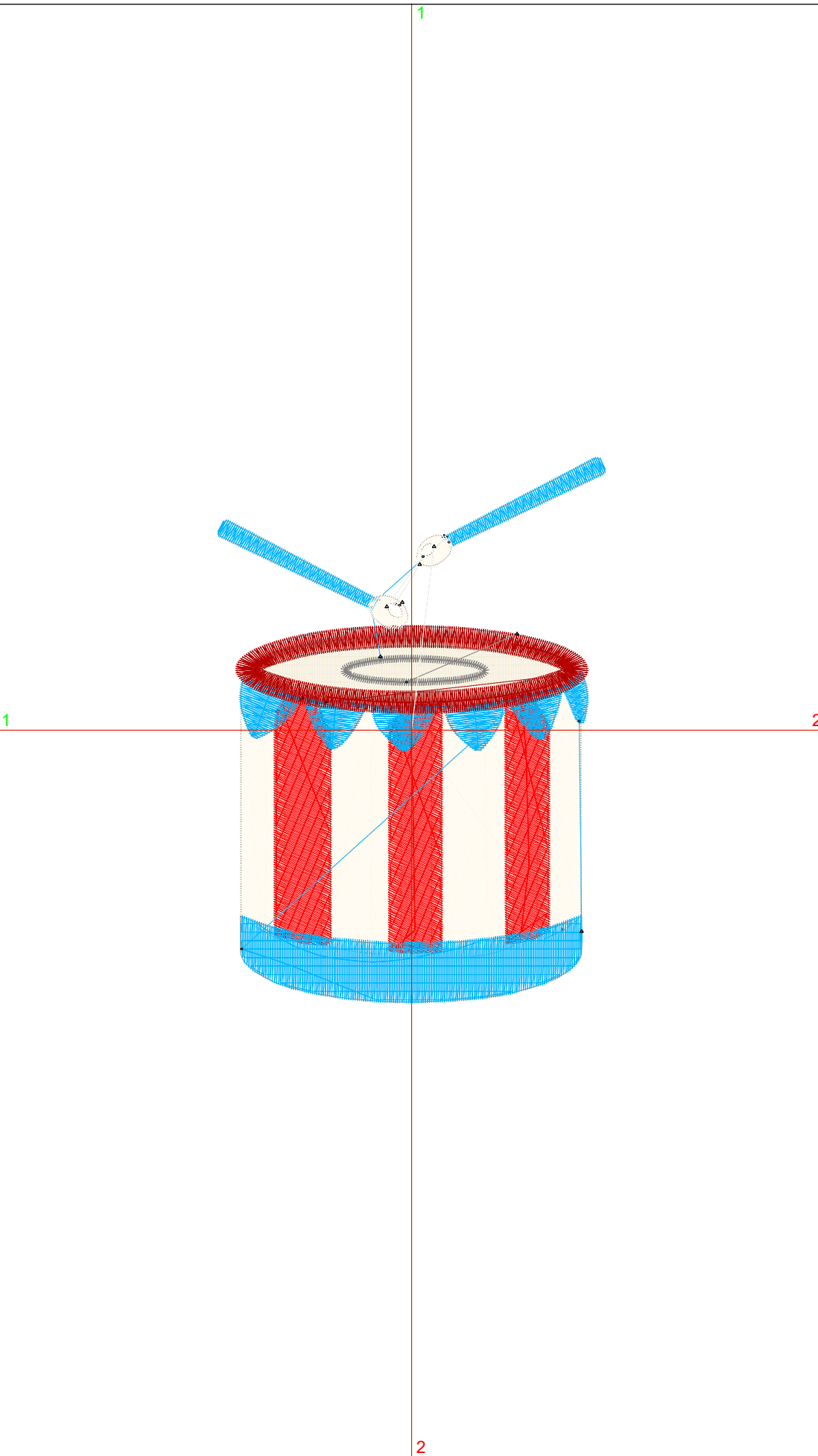

Stop Sequence:

#	#	Color	St.	Code	Name	Chart
1.	3	White	4,633	4	Wilcom	
2.	4	Red	2,966	5	Red	Wilcom
3.	1	Cyan	2,486	2	Cyan	Wilcom
4.	2	White	1,264	3	Wilcom	
5.	5	Red	1,111	7	Wilcom	
6.	6	Grey	345	14	Grey	Wilcom
7.	1	Cyan	442	2	Cyan	Wilcom
8.	3	White	151	4	Wilcom	
9.	7	White	57	15	White	Wilcom

Color Film

Wilcom TrueSizer



Design: **Carnival Drum**

Title: **Carnival Drum**

Stitches: 13,457
Height: 3.82 in
Width: 2.71 in
Colors: 7
Colorway: Colorway 1
Zoom: 0.49

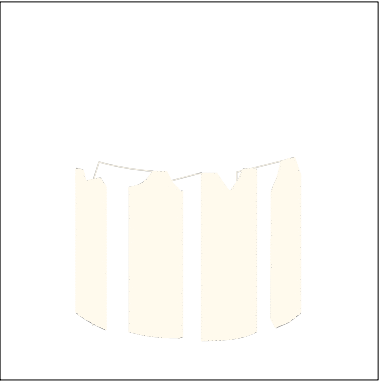

Stop #: 1
Code: 4
Name:
Chart: Wilcom
Stitches: 4,633
Thread used: 84.26ft

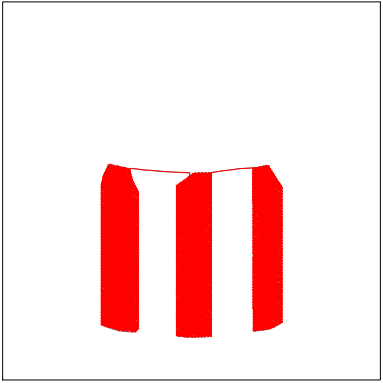

Stop #: 2
Code: 5
Name: Red
Chart: Wilcom
Stitches: 2,966
Thread used: 52.65ft

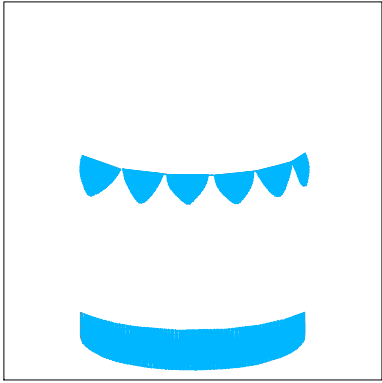

Stop #: 3
Code: 2
Name: Cyan
Chart: Wilcom
Stitches: 2,486
Thread used: 45.02ft

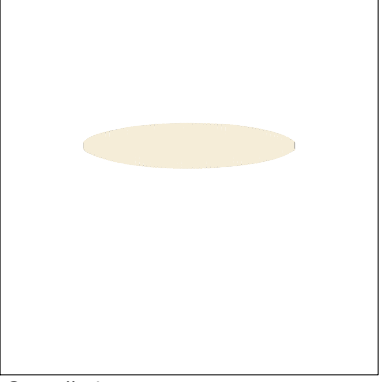

Stop #: 4
Code: 3
Name:
Chart: Wilcom
Stitches: 1,264
Thread used: 23.00ft

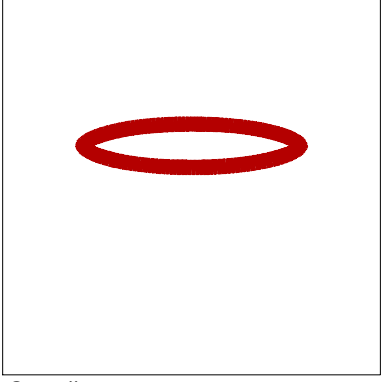

Stop #: 5
Code: 7
Name:
Chart: Wilcom
Stitches: 1,111
Thread used: 22.53ft

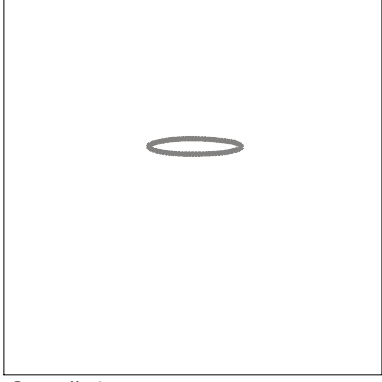

Stop #: 6
Code: 14
Name: Grey
Chart: Wilcom
Stitches: 345
Thread used: 4.23ft

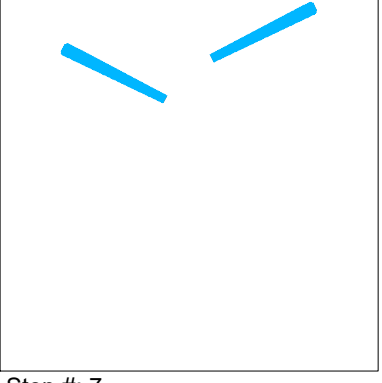

Stop #: 7
Code: 2
Name: Cyan
Chart: Wilcom
Stitches: 442
Thread used: 8.13ft



Stop #: 8
Code: 4
Name:
Chart: Wilcom
Stitches: 151
Thread used: 3.06ft

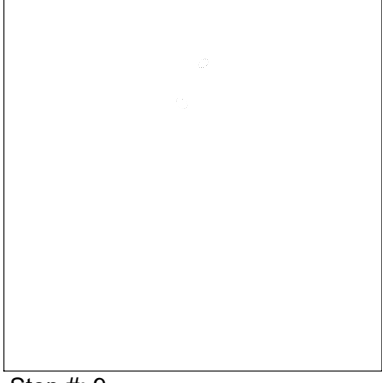

Stop #: 9
Code: 15
Name: White
Chart: Wilcom
Stitches: 57
Thread used: 0.69ft