

Michaels®

Embroidery Design
Sewing Information

Production Worksheet

Wilcom TrueSizer



Design: **Yoga Mat**

Title: **Yoga Mat**

Stitches: 8,633
 Height: 2.63 in
 Width: 3.81 in
 Colors: 6
 Colorway: Colorway 1
 Zoom: 1:1

Machine format: Tajima
 Color changes: 5
 Stops: 6
 Trims: 6
 Auto fabric: Pure Cotton
 Required stabilizer: Topping:
 Backing: Tear Away
 x 2
 Appliqués: 0
 Left: 48.4 mm
 Right: 48.4 mm
 Up: 33.5 mm
 Down: 33.5 mm
 EndX: 0.00 in
 EndY: 0.00 in
 Area: 10.04 in²
 Max stitch: 10.3 mm
 Min stitch: 0.2 mm
 Max jump: 7.0 mm
 Total thread: 176.78ft
 Total bobbin: 70.03ft

Stop Sequence:

#	#	Color	St.	Code	Name	Chart
1.	5		3,102	5	Wilcom	
2.	7		3,007	7	Wilcom	
3.	4		312	4	Wilcom	
4.	6		292	6	Wilcom	
5.	3		940	3	Wilcom	
6.	2		978	2	Wilcom	

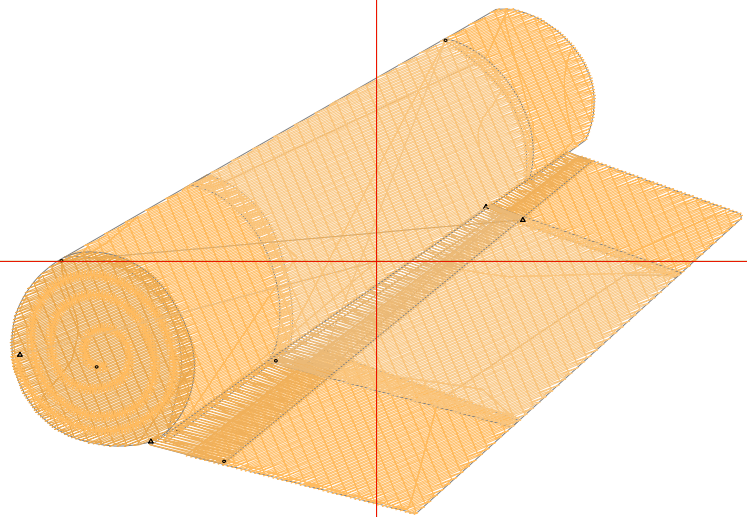

Color Film

Wilcom TrueSizer



Design: **Yoga Mat**

Title: **Yoga Mat**

Stitches: 8,633
Height: 2.63 in
Width: 3.81 in
Colors: 6
Colorway: Colorway 1
Zoom: 0.49

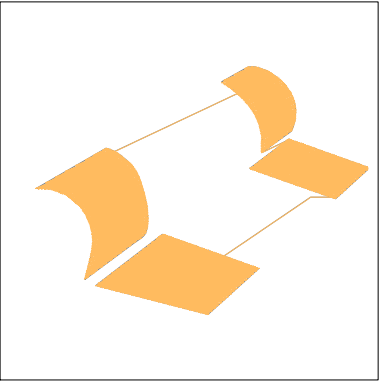

Stop #: 1
Code: 5
Name:
Chart: Wilcom
Stitches: 3,102
Thread used: 61.86ft

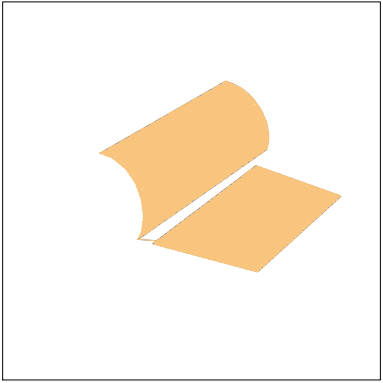

Stop #: 2
Code: 7
Name:
Chart: Wilcom
Stitches: 3,007
Thread used: 64.58ft

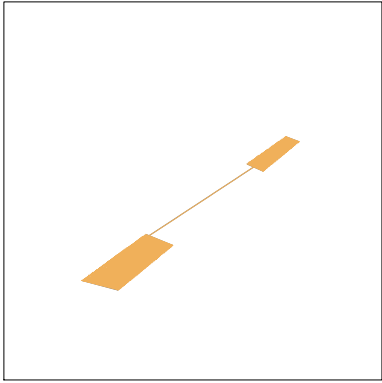

Stop #: 3
Code: 4
Name:
Chart: Wilcom
Stitches: 312
Thread used: 8.71ft

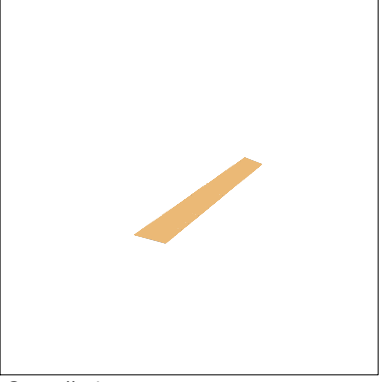

Stop #: 4
Code: 6
Name:
Chart: Wilcom
Stitches: 292
Thread used: 8.05ft

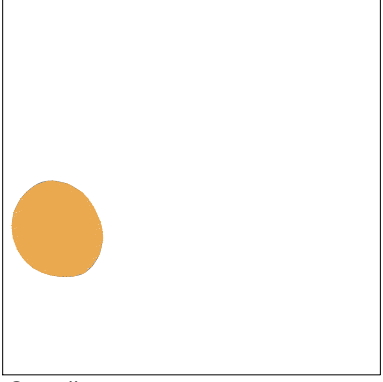

Stop #: 5
Code: 3
Name:
Chart: Wilcom
Stitches: 940
Thread used: 19.42ft

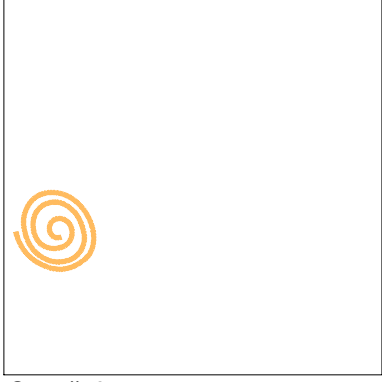

Stop #: 6
Code: 2
Name:
Chart: Wilcom
Stitches: 978
Thread used: 12.18ft