

Michaels®

Embroidery Design
Sewing Information

Production Worksheet

Wilcom TrueSizer



Design: **Front-Face of a Car**

Title: **Front-Face of a Car**

Stitches: 9,330
 Height: 2.33 in
 Width: 3.80 in
 Colors: 6
 Colorway: Colorway 1
 Zoom: 1:1

Machine format: Tajima
 Color changes: 6
 Stops: 7
 Trims: 10
 Auto fabric: Pure Cotton
 Required stabilizer: Topping:
 Backing: Tear Away x 2
 Appliqués: 0
 Left: 48.3 mm
 Right: 48.3 mm
 Up: 29.6 mm
 Down: 29.6 mm
 EndX: 0.00 in
 EndY: 0.00 in
 Area: 8.85 in²
 Max stitch: 6.9 mm
 Min stitch: 0.3 mm
 Max jump: 6.9 mm
 Total thread: 185.00ft
 Total bobbin: 71.99ft

Stop Sequence:

#	#	Color	St.	Code	Name	Chart
1.	11		1,802	11	Dark Brown	Wilcom
2.	26		4,962	26	Light Green	Wilcom
3.	14		544	14	Grey	Wilcom
4.	13		1,095	13	Black	Wilcom
5.	11		413	11	Dark Brown	Wilcom
6.	2		82	2	Cyan	Wilcom
7.	1		430	1	Blue	Wilcom

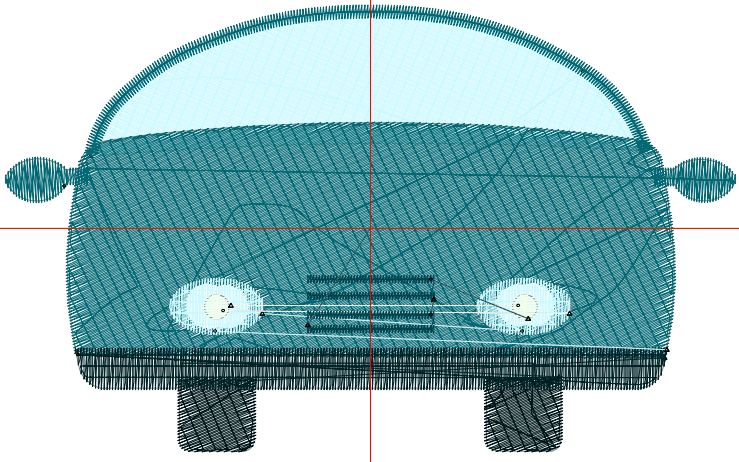

Color Film

Wilcom TrueSizer



Design: **Front-Face of a Car**
Title: **Front-Face of a Car**

Stitches: 9,330
Height: 2.33 in
Width: 3.80 in
Colors: 6
Colorway: Colorway 1
Zoom: 0.49

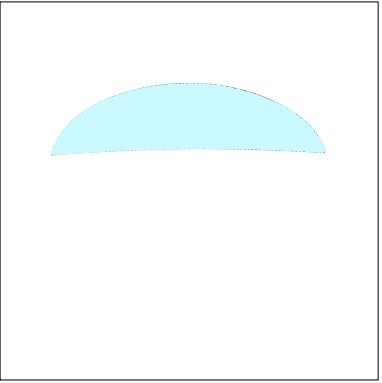

Stop #: 1
Code: 11
Name: Dark Brown
Chart: Wilcom
Stitches: 1,802
Thread used: 38.57ft

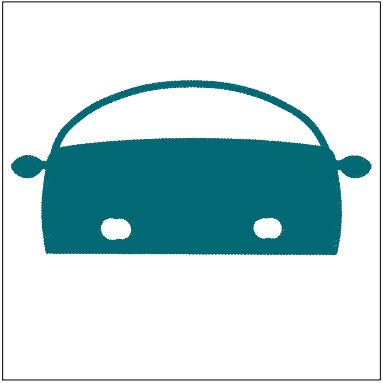

Stop #: 2
Code: 26
Name: Light Green
Chart: Wilcom
Stitches: 4,962
Thread used: 103.13ft

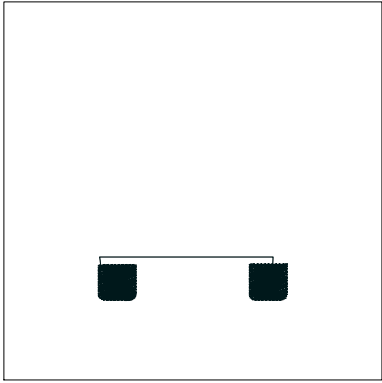

Stop #: 3
Code: 14
Name: Grey
Chart: Wilcom
Stitches: 544
Thread used: 9.46ft

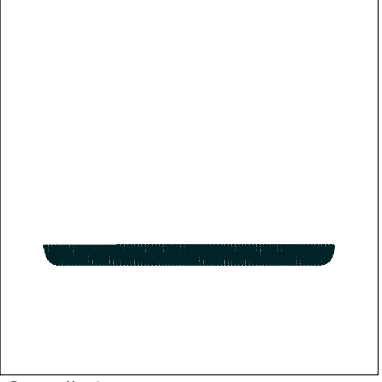

Stop #: 4
Code: 13
Name: Black
Chart: Wilcom
Stitches: 1,095
Thread used: 18.60ft

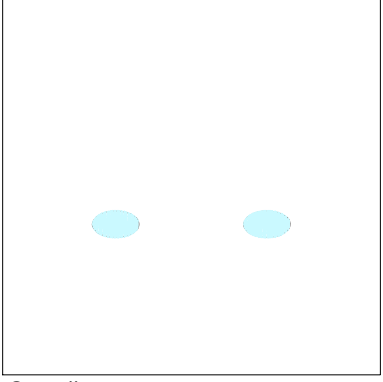

Stop #: 5
Code: 11
Name: Dark Brown
Chart: Wilcom
Stitches: 413
Thread used: 6.84ft

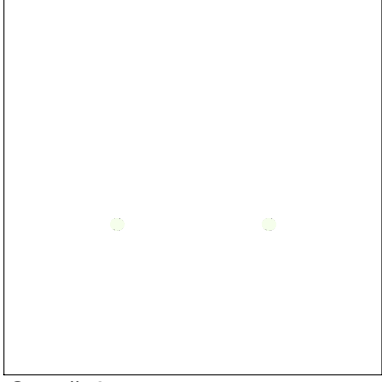

Stop #: 6
Code: 2
Name: Cyan
Chart: Wilcom
Stitches: 82
Thread used: 1.21ft

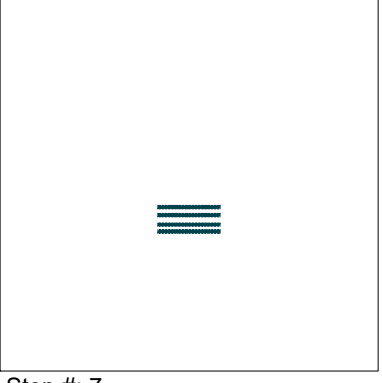

Stop #: 7
Code: 1
Name: Blue
Chart: Wilcom
Stitches: 430
Thread used: 4.88ft