

Michaels®

Embroidery Design
Sewing Information

Production Worksheet

Wilcom TrueSizer



Design: Blue Car

Title: Blue Car

Stitches: 13,285
 Height: 2.68 in
 Width: 3.80 in
 Colors: 6
 Colorway: Colorway 1
 Zoom: 1:1

Machine format: Tajima
 Color changes: 5
 Stops: 6
 Trims: 20
 Auto fabric: Pure Cotton
 Required stabilizer: Topping:
 Backing: Tear Away
 x 2
 Appliqués: 0
 Left: 48.2 mm
 Right: 48.2 mm
 Up: 34.0 mm
 Down: 34.0 mm
 EndX: 0.00 in
 EndY: 0.00 in
 Area: 10.17 in²
 Max stitch: 6.9 mm
 Min stitch: 0.4 mm
 Max jump: 6.9 mm
 Total thread: 249.06ft
 Total bobbin: 94.77ft

Stop Sequence:

#	#	Color	St.	Code	Name	Chart
1.	37	■	4,601	37	Wilcom	
2.	12	□	2,295	12	Wilcom	
3.	35	■	4,384	35	Wilcom	
4.	21	■	616	21	Wilcom	
5.	1	■	845	13	Wilcom	
6.	15	□	542	15	Wilcom	

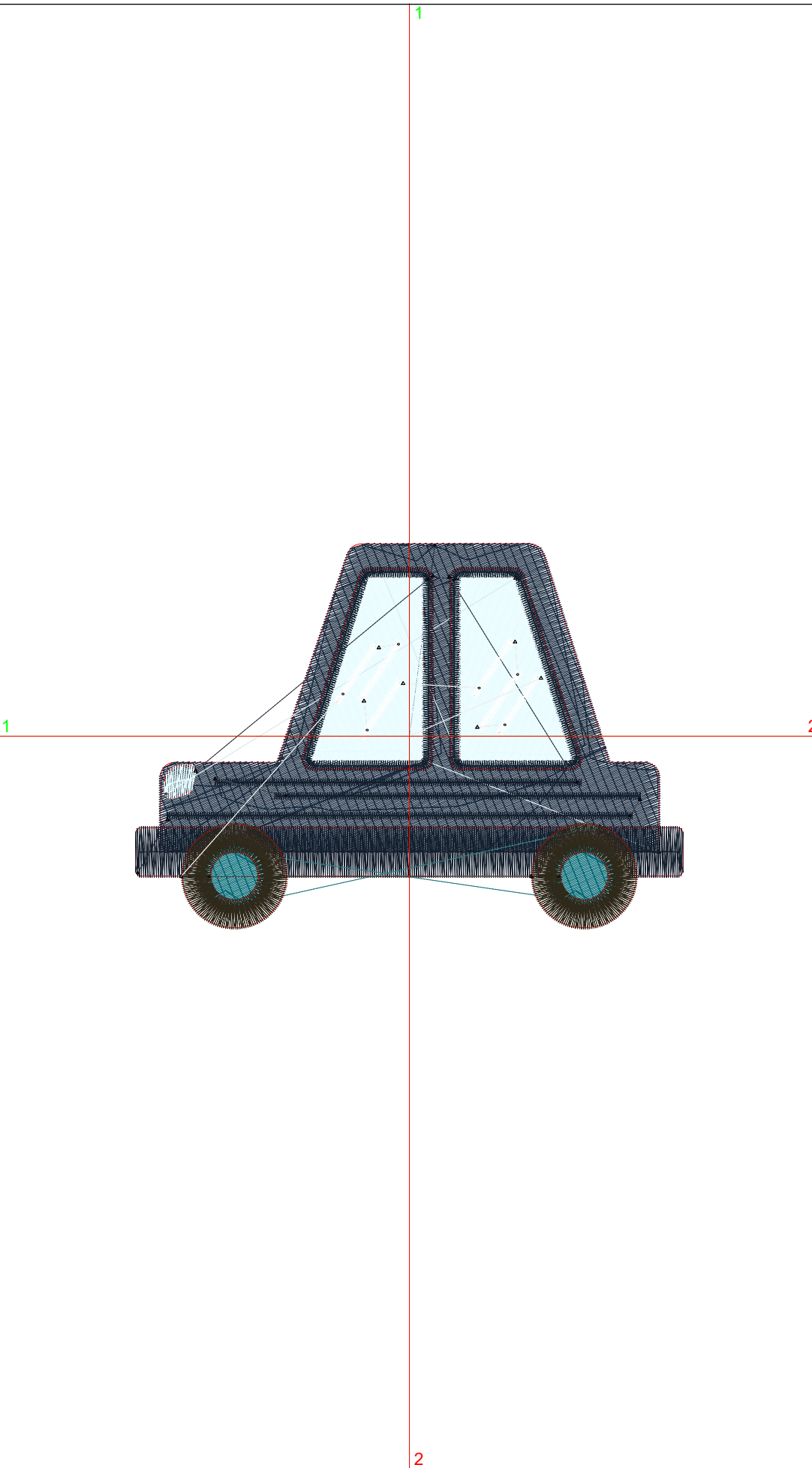

Color Film

Wilcom TrueSizer



Design: Blue Car

Title: Blue Car

Stitches: 13,285
Height: 2.68 in
Width: 3.80 in
Colors: 6
Colorway: Colorway 1
Zoom: 0.49

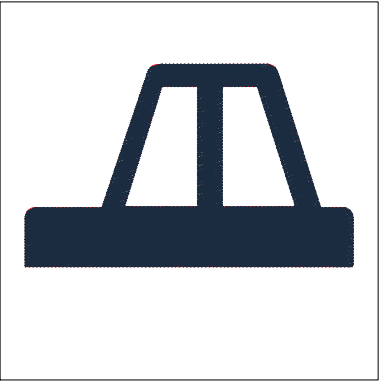

Stop #: 1
Code: 37
Name:
Chart: Wilcom
Stitches: 4,601
Thread used: 92.68ft

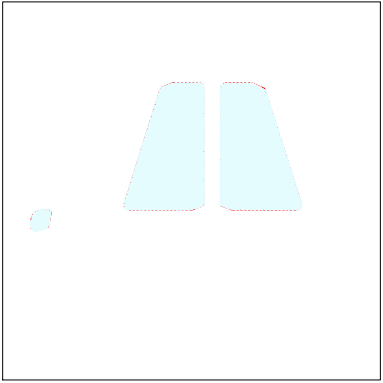

Stop #: 2
Code: 12
Name:
Chart: Wilcom
Stitches: 2,295
Thread used: 47.13ft

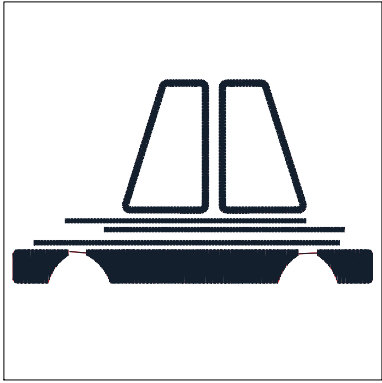

Stop #: 3
Code: 35
Name:
Chart: Wilcom
Stitches: 4,384
Thread used: 66.47ft

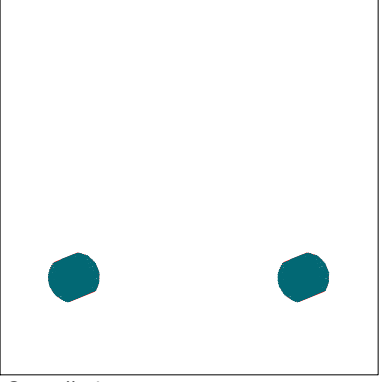

Stop #: 4
Code: 21
Name:
Chart: Wilcom
Stitches: 616
Thread used: 11.46ft

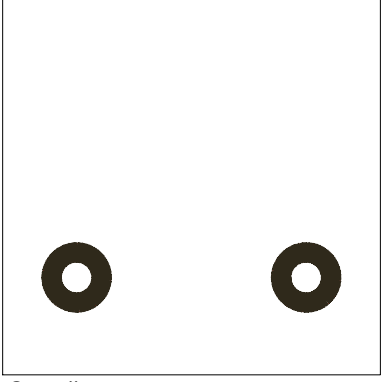

Stop #: 5
Code: 13
Name:
Chart: Wilcom
Stitches: 845
Thread used: 22.88ft

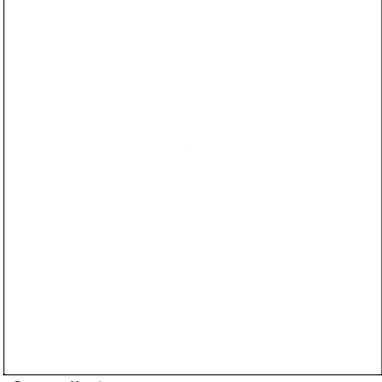

Stop #: 6
Code: 15
Name:
Chart: Wilcom
Stitches: 542
Thread used: 6.47ft