

*Michaels*<sup>®</sup>

**Embroidery Design  
Sewing Information**

# Production Worksheet

Wilcom TrueSizer



Design: **Telescope**

Title: **Telescope**

Stitches: 6,476  
 Height: 3.81 in  
 Width: 3.40 in  
 Colors: 3  
 Colorway: Colorway 1  
 Zoom: 1:1

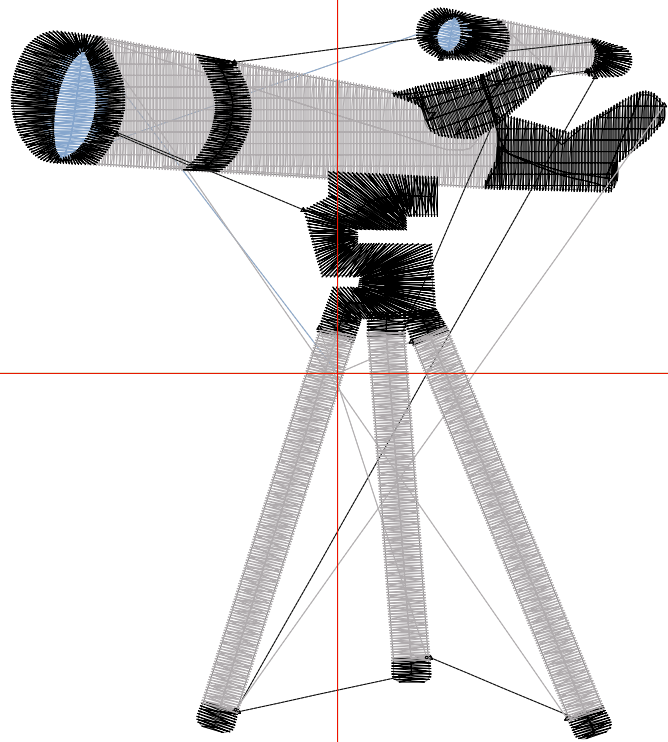

Machine format: Tajima  
 Color changes: 5  
 Stops: 6  
 Trims: 15  
 Auto fabric: Pure Cotton  
 Required stabilizer: Topping:  
 Backing: Tear Away  
 x 2  
 Appliqués: 0  
 Left: 43.2 mm  
 Right: 43.2 mm  
 Up: 48.3 mm  
 Down: 48.3 mm  
 EndX: 0.00 in  
 EndY: 0.00 in  
 Area: 12.94 in<sup>2</sup>  
 Max stitch: 7.4 mm  
 Min stitch: 0.3 mm  
 Max jump: 6.9 mm  
 Total thread: 128.88ft  
 Total bobbin: 50.03ft

Stop Sequence:

#	#	Color	St.	Code	Name	Chart
1.	3	Blue	414	3		Wilcom
2.	2	Grey	253	2		Wilcom
3.	13	Black	146	13	Black	Wilcom
4.	2	Grey	1,487	2		Wilcom
5.	13	Black	2,788	13	Black	Wilcom
6.	2	Grey	1,386	2		Wilcom

**Color Film**

Wilcom TrueSizer



Design: **Telescope**

Title: **Telescope**

Stitches: 6,476  
Height: 3.81 in  
Width: 3.40 in  
Colors: 3  
Colorway: Colorway 1  
Zoom: 0.49

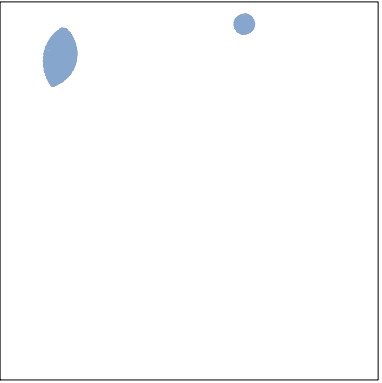

Stop #: 1  
Code: 3  
Name:  
Chart: Wilcom  
Stitches: 414  
Thread used: 6.92ft

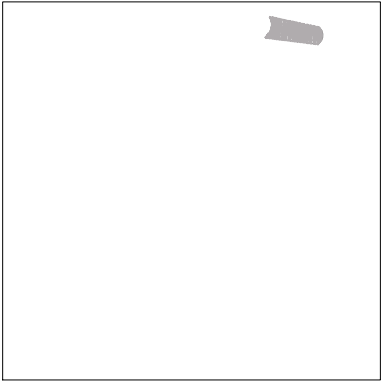

Stop #: 2  
Code: 2  
Name:  
Chart: Wilcom  
Stitches: 253  
Thread used: 3.96ft

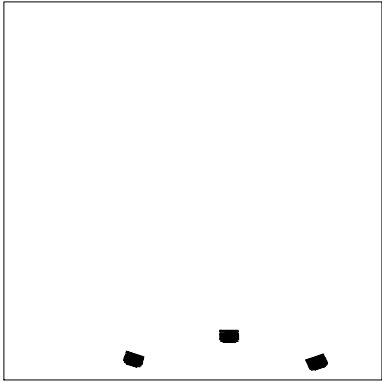

Stop #: 3  
Code: 13  
Name: Black  
Chart: Wilcom  
Stitches: 146  
Thread used: 2.77ft

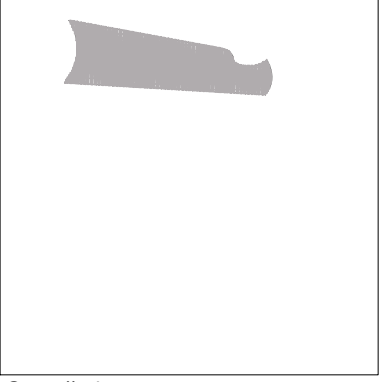

Stop #: 4  
Code: 2  
Name:  
Chart: Wilcom  
Stitches: 1,487  
Thread used: 29.17ft

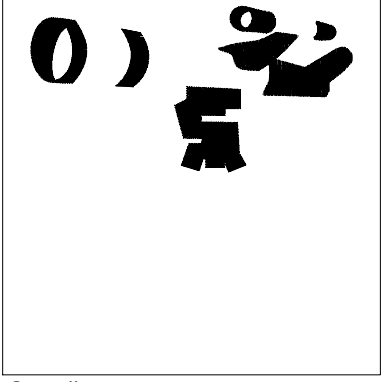

Stop #: 5  
Code: 13  
Name: Black  
Chart: Wilcom  
Stitches: 2,788  
Thread used: 51.30ft

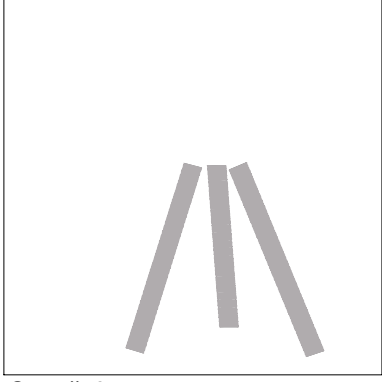

Stop #: 6  
Code: 2  
Name:  
Chart: Wilcom  
Stitches: 1,386  
Thread used: 32.79ft