

Michaels®

Embroidery Design  
Sewing Information

# Production Worksheet

Wilcom TrueSizer



Design: **Flashlight**

Title: **Flashlight**

Stitches: 13,480  
Height: 2.20 in  
Width: 3.81 in  
Colors: 12  
Colorway: Colorway 1  
Zoom: 1:1

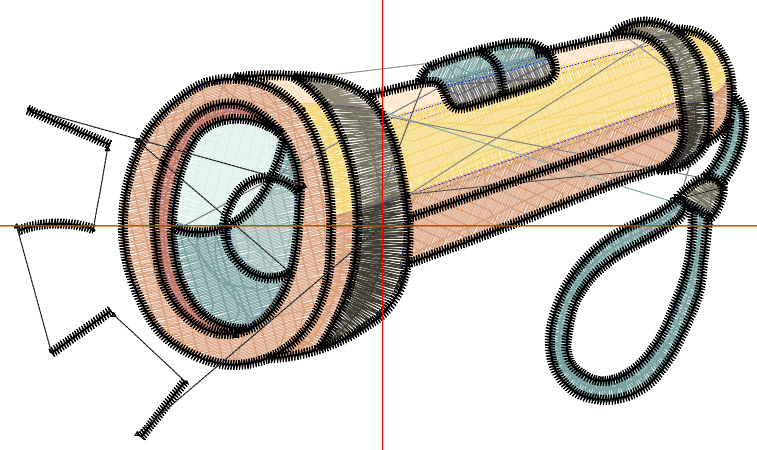

# Production Worksheet

Wilcom TrueSizer



Design: **Flashlight**

Title: **Flashlight**

Stitches: 13,480  
 Height: 2.20 in  
 Width: 3.81 in  
 Colors: 12  
 Colorway: Colorway 1  
 Zoom: 1:1

Machine format: Tajima  
 Color changes: 13  
 Stops: 14  
 Trims: 23  
 Auto fabric: Custom Fabric  
 Required stabilizer: Topping:  
 Backing: Tear Away x 2  
 Appliqués: 0  
 Left: 48.4 mm  
 Right: 48.4 mm  
 Up: 27.6 mm  
 Down: 28.3 mm  
 EndX: 0.00 in  
 EndY: 0.00 in  
 Area: 8.40 in<sup>2</sup>  
 Max stitch: 12.0 mm  
 Min stitch: 0.3 mm  
 Max jump: 6.9 mm  
 Total thread: 205.91ft  
 Total bobbin: 66.88ft

Stop Sequence:

| #   | #  | Color | St.   | Code            | Name     | Chart                |
|-----|----|-------|-------|-----------------|----------|----------------------|
| 1.  | 37 |       | 466   | Send            | PMS 453  | Madeira Classic 1138 |
| 2.  | 20 |       | 1,312 | Light Yellow    | PMS 114  | Madeira Classic 1135 |
| 3.  | 21 |       | 2,282 | Masturd         | PMS 124  | Madeira Classic 1025 |
| 4.  | 10 |       | 538   | Orange          | PMS 151  | Madeira Classic 1278 |
| 5.  | 33 |       | 470   | Gray            | PMS 430  | Madeira Classic 1118 |
| 6.  | 26 |       | 241   | Light sea green | PMS 3255 | Madeira Classic 1299 |
| 7.  | 34 |       | 363   | Light Gray      | PMS 429  | Madeira Classic 1011 |
| 8.  | 38 |       | 198   | Thread #18      |          |                      |
| 9.  | 33 |       | 194   | Gray            | PMS 430  | Madeira Classic 1118 |
| 10. | 24 |       | 623   | Dark Green      | PMS 3435 | Madeira Classic 1370 |
| 11. | 27 |       | 232   | Green           | PMS 355  | Madeira Classic 1251 |
| 12. | 33 |       | 598   | Gray            | PMS 430  | Madeira Classic 1118 |
| 13. | 22 |       | 560   | Mahndi Green    | PMS 3435 | Madeira Classic 1370 |
| 14. | 12 |       | 5,401 | Black           |          | Madeira Classic 1000 |

# Color Film

Wilcom TrueSizer



Design: **Flashlight**

Title: **Flashlight**

Stitches: 13,480  
Height: 2.20 in  
Width: 3.81 in  
Colors: 12  
Colorway: Colorway 1  
Zoom: 0.49

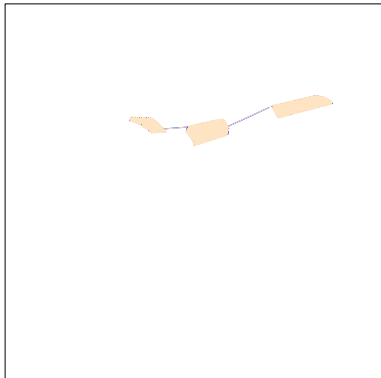

Stop #: 1  
Code: Send  
Name: PMS 453  
Chart: Madeira Classic 1138  
Stitches: 466  
Thread used: 6.96ft

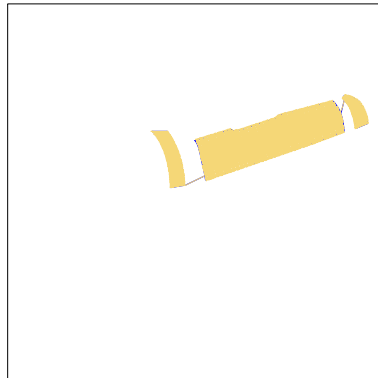

Stop #: 2  
Code: Light Yellow  
Name: PMS 114  
Chart: Madeira Classic 1135  
Stitches: 1,312  
Thread used: 23.23ft

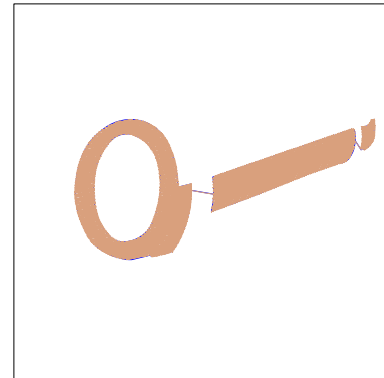

Stop #: 3  
Code: Masturd  
Name: PMS 124  
Chart: Madeira Classic 1025  
Stitches: 2,282  
Thread used: 39.64ft

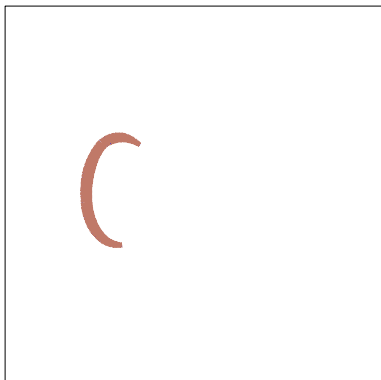

Stop #: 4  
Code: Orange  
Name: PMS 151  
Chart: Madeira Classic 1278  
Stitches: 538  
Thread used: 7.23ft

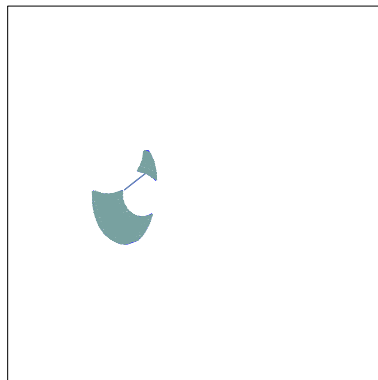

Stop #: 5  
Code: Gray  
Name: PMS 430  
Chart: Madeira Classic 1118  
Stitches: 470  
Thread used: 7.94ft

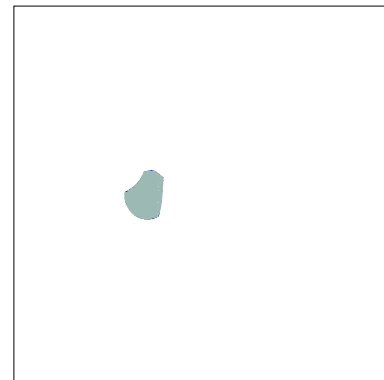

Stop #: 6  
Code: Light sea green  
Name: PMS 3255  
Chart: Madeira Classic 1299  
Stitches: 241  
Thread used: 4.35ft

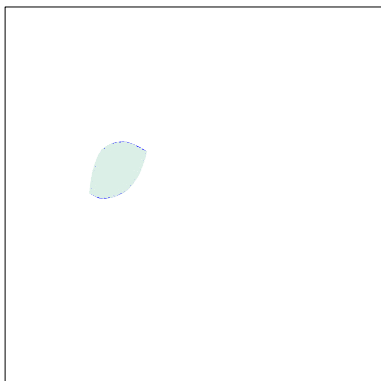

Stop #: 7  
Code: Light Gray  
Name: PMS 429  
Chart: Madeira Classic 1011  
Stitches: 363  
Thread used: 6.82ft

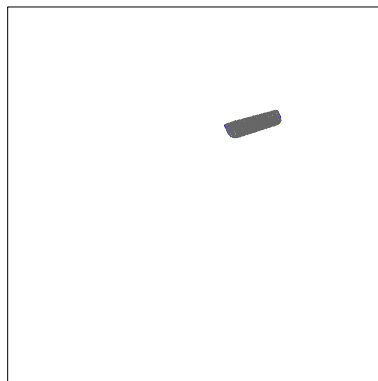

Stop #: 8  
Code:  
Name: Thread #18  
Chart:  
Stitches: 198  
Thread used: 3.08ft

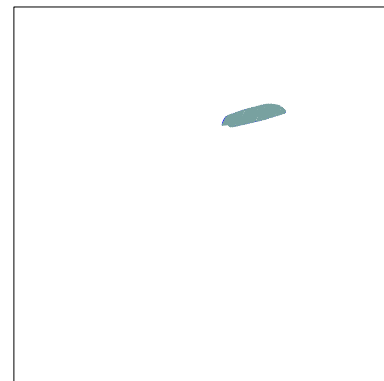

Stop #: 9  
Code: Gray  
Name: PMS 430  
Chart: Madeira Classic 1118  
Stitches: 194  
Thread used: 2.91ft

# Color Film

Wilcom TrueSizer



Design: **Flashlight**

Title: **Flashlight**

Stitches: 13,480  
Height: 2.20 in  
Width: 3.81 in  
Colors: 12  
Colorway: Colorway 1  
Zoom: 0.49

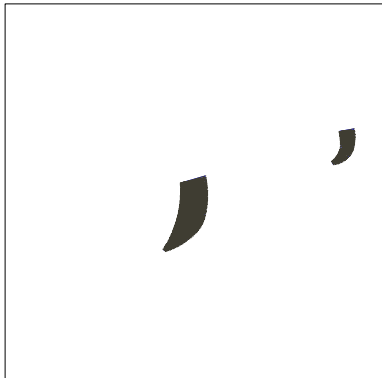

Stop #: 10  
Code: Dark Green  
Name: PMS 3435  
Chart: Madeira Classic 1370  
Stitches: 623  
Thread used: 9.70ft



Stop #: 11  
Code: Green  
Name: PMS 355  
Chart: Madeira Classic 1251  
Stitches: 232  
Thread used: 3.32ft



Stop #: 12  
Code: Gray  
Name: PMS 430  
Chart: Madeira Classic 1118  
Stitches: 598  
Thread used: 10.71ft



Stop #: 13  
Code: Mahndi Green  
Name: PMS 3435  
Chart: Madeira Classic 1370  
Stitches: 560  
Thread used: 8.83ft

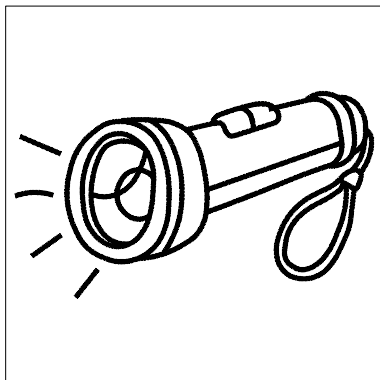

Stop #: 14  
Code: Black  
Name:  
Chart: Madeira Classic 1000  
Stitches: 5,401  
Thread used: 66.59ft