

Michaels®

Embroidery Design  
Sewing Information

# Production Worksheet

Wilcom TrueSizer



Design: **Irish Lifestyle**

Title: **Irish Lifestyle**

Stitches: 16,655  
 Height: 3.82 in  
 Width: 3.16 in  
 Colors: 5  
 Colorway: Colorway 1  
 Zoom: 1:1

Machine format: Tajima  
 Color changes: 5  
 Stops: 6  
 Trims: 17  
 Auto fabric: Pure Cotton  
 Required stabilizer: Topping:  
 Backing: Tear Away  
 x 2  
 Appliqués: 0  
 Left: 40.2 mm  
 Right: 40.2 mm  
 Up: 48.5 mm  
 Down: 48.5 mm  
 EndX: 0.00 in  
 EndY: 0.00 in  
 Area: 12.08 in<sup>2</sup>  
 Max stitch: 7.6 mm  
 Min stitch: 0.3 mm  
 Max jump: 6.8 mm  
 Total thread: 349.63ft  
 Total bobbin: 141.26ft

Stop Sequence:

#	#	Color	St.	Code	Name	Chart
1.	6	■	9,318	6	Wilcom	
2.	5	■	6,020	5	Wilcom	
3.	4	■	332	4	Wilcom	
4.	2	■	709	2	Wilcom	
5.	3	■	59	3	Wilcom	
6.	5	■	215	5	Wilcom	

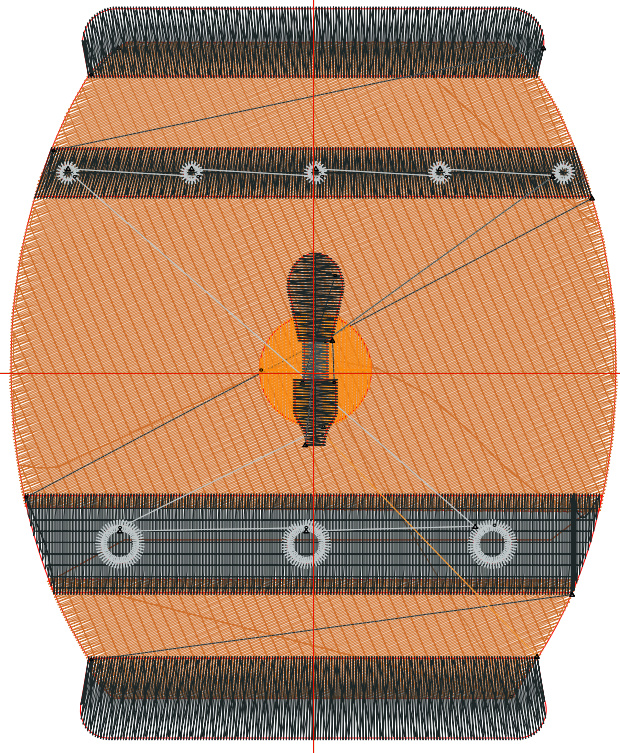

# Color Film

Wilcom TrueSizer



Design: **Irish Lifestyle**

Title: **Irish Lifestyle**

Stitches: 16,655  
Height: 3.82 in  
Width: 3.16 in  
Colors: 5  
Colorway: Colorway 1  
Zoom: 0.49

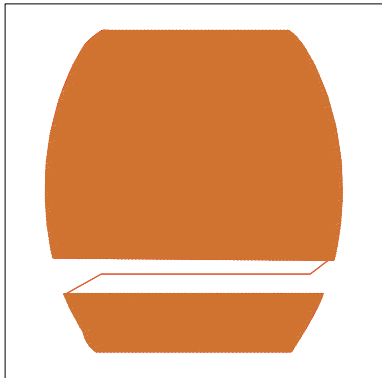

Stop #: 1  
Code: 6  
Name:  
Chart: Wilcom  
Stitches: 9,318  
Thread used: 210.38ft

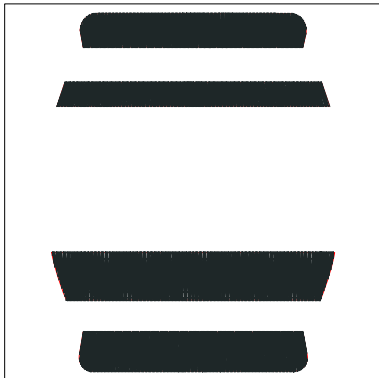

Stop #: 2  
Code: 5  
Name:  
Chart: Wilcom  
Stitches: 6,020  
Thread used: 116.96ft

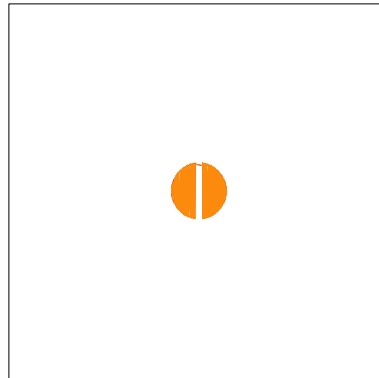

Stop #: 3  
Code: 4  
Name:  
Chart: Wilcom  
Stitches: 332  
Thread used: 6.03ft

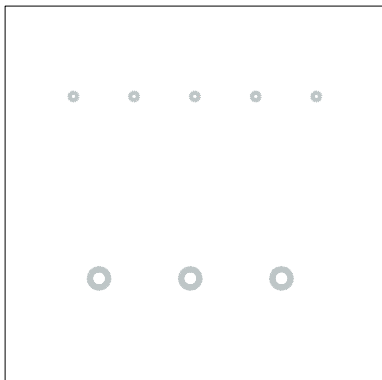

Stop #: 4  
Code: 2  
Name:  
Chart: Wilcom  
Stitches: 709  
Thread used: 8.22ft

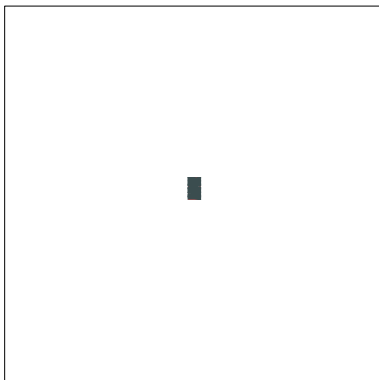

Stop #: 5  
Code: 3  
Name:  
Chart: Wilcom  
Stitches: 59  
Thread used: 1.10ft

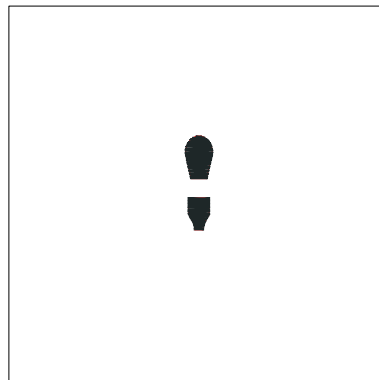

Stop #: 6  
Code: 5  
Name:  
Chart: Wilcom  
Stitches: 215  
Thread used: 4.96ft