

Michaels®

Embroidery Design
Sewing Information

Production Worksheet

Wilcom TrueSizer



Design: **Record Player**

Title: **Record Player**

Stitches: 11,878
 Height: 1.89 in
 Width: 3.81 in
 Colors: 13
 Colorway: Colorway 1
 Zoom: 1:1

Machine format: Tajima
 Color changes: 17
 Stops: 18
 Trims: 28
 Auto fabric: Custom Fabric
 Required stabilizer: Topping:
 Backing: Tear Away x 2
 Appliqués: 0
 Left: 48.4 mm
 Right: 48.4 mm
 Up: 23.5 mm
 Down: 24.5 mm
 EndX: 0.00 in
 EndY: 0.00 in
 Area: 7.20 in²
 Max stitch: 10.8 mm
 Min stitch: 0.3 mm
 Max jump: 7.0 mm
 Total thread: 236.46ft
 Total bobbin: 90.44ft

Stop Sequence:

#	#	Color	St.	Code	Name	Chart
1.	5	■	165	Dark Blue	PMS 295	Madeira Classic 1376
2.	6	■	4,022	Powder Blue	PMS 283	Madeira Classic 1274
3.	32	■	2,413	Dark Gray	PMS 431	Madeira Classic 1041
4.	13	■	453	White		Madeira Classic 1005
5.	9	■	833	Dark Orange	PMS 1655	Madeira Classic 1078
6.	11	■	421	Light Orange	PMS 150	Madeira Classic 1155
7.	33	■	1,076	Gray	PMS 430	Madeira Classic 1118
8.	14	■	27	Brown	PMS 4635	Madeira Classic 1258
9.	12	■	30	Black		Madeira Classic 1000
10.	5	■	206	Dark Blue	PMS 295	Madeira Classic 1376
11.	3	■	179	Navy Blue	PMS 2766	Madeira Classic 1242
12.	4	■	222	Sky Blue	PMS 311	Madeira Classic 1094
13.	3	■	54	Navy Blue	PMS 2766	Madeira Classic 1242
14.	10	■	102	Orange	PMS 151	Madeira Classic 1278
15.	13	■	284	White		Madeira Classic 1005
16.	1	■	81	New Blue	PMS 2718	Madeira Classic 1143
17.	4	■	1,090	Sky Blue	PMS 311	Madeira Classic 1094
18.	5	■	218	Dark Blue	PMS 295	Madeira Classic 1376

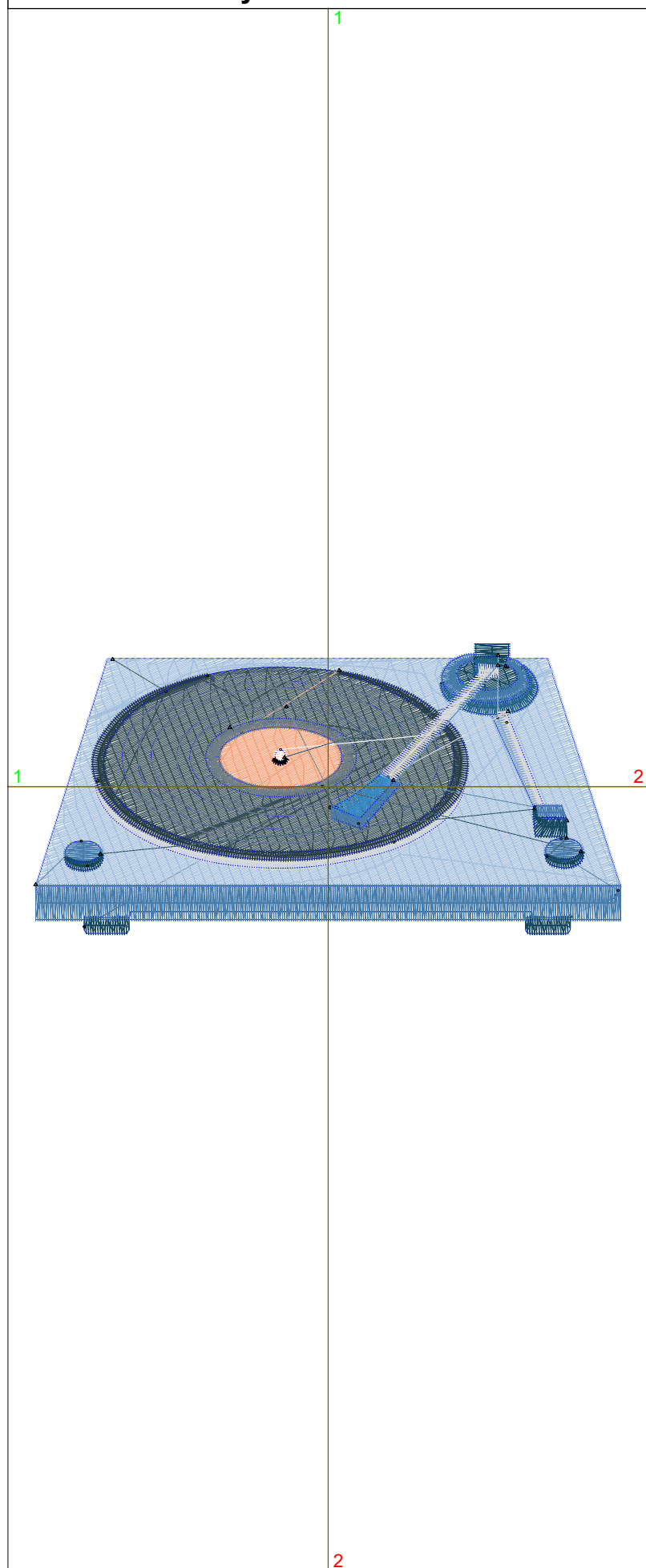

Color Film

Wilcom TrueSizer



Design: **Record Player**

Title: **Record Player**

Stitches: 11,878
Height: 1.89 in
Width: 3.81 in
Colors: 13
Colorway: Colorway 1
Zoom: 0.49

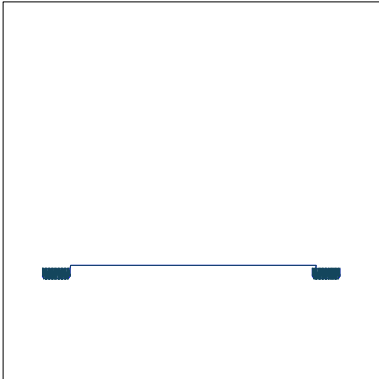

Stop #: 1
Code: Dark Blue
Name: PMS 295
Chart: Madeira Classic 1376
Stitches: 165
Thread used: 2.77ft

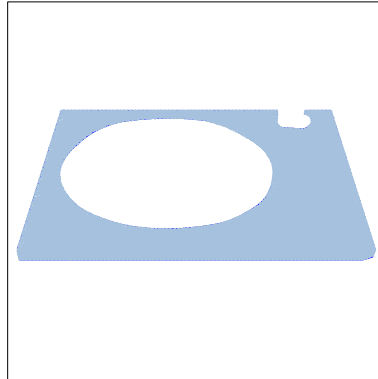

Stop #: 2
Code: Powder Blue
Name: PMS 283
Chart: Madeira Classic 1274
Stitches: 4,022
Thread used: 83.32ft

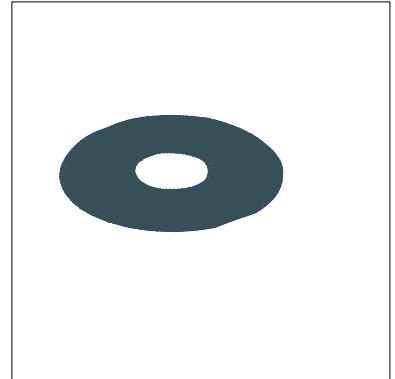

Stop #: 3
Code: Dark Gray
Name: PMS 431
Chart: Madeira Classic 1041
Stitches: 2,413
Thread used: 52.16ft

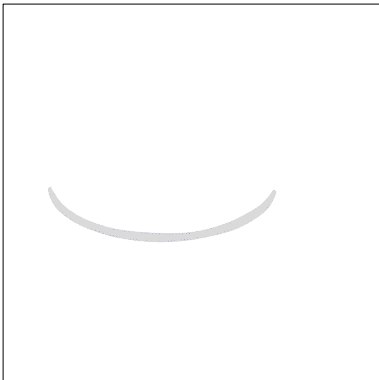

Stop #: 4
Code: White
Name:
Chart: Madeira Classic 1005
Stitches: 453
Thread used: 6.86ft

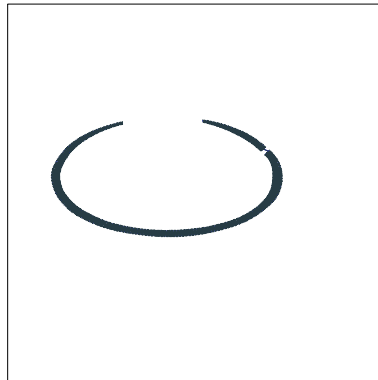

Stop #: 5
Code: Dark Orange
Name: PMS 1655
Chart: Madeira Classic 1078
Stitches: 833
Thread used: 11.79ft

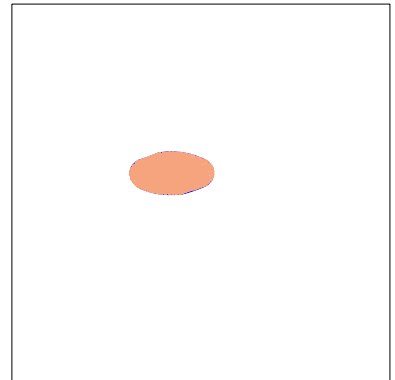

Stop #: 6
Code: Light Orange
Name: PMS 150
Chart: Madeira Classic 1155
Stitches: 421
Thread used: 8.45ft

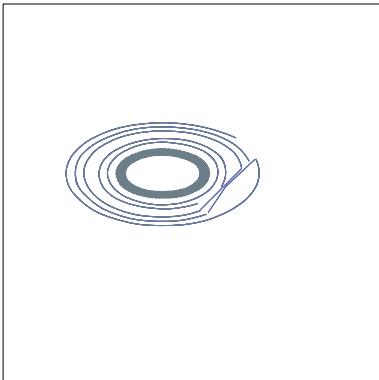

Stop #: 7
Code: Gray
Name: PMS 430
Chart: Madeira Classic 1118
Stitches: 1,076
Thread used: 15.16ft

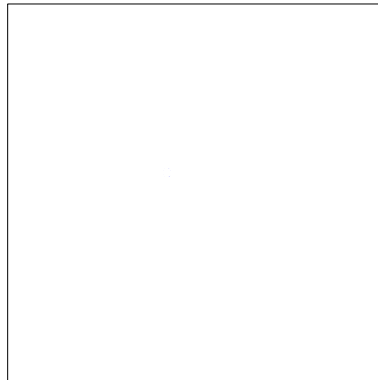

Stop #: 8
Code: Brown
Name: PMS 4635
Chart: Madeira Classic 1258
Stitches: 27
Thread used: 0.34ft

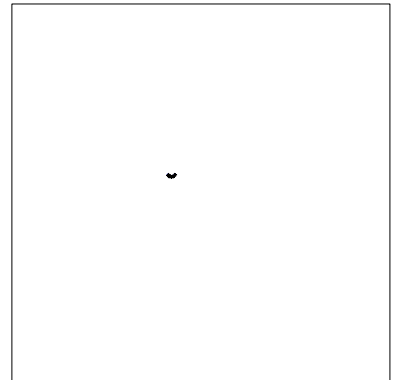

Stop #: 9
Code: Black
Name:
Chart: Madeira Classic 1000
Stitches: 30
Thread used: 0.30ft

Color Film

Wilcom TrueSizer



Design: **Record Player**

Title: **Record Player**

Stitches: 11,878
Height: 1.89 in
Width: 3.81 in
Colors: 13
Colorway: Colorway 1
Zoom: 0.49

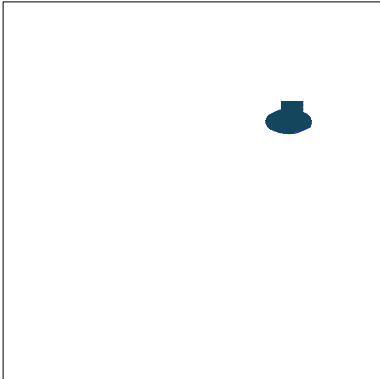

Stop #: 10
Code: Dark Blue
Name: PMS 295
Chart: Madeira Classic 1376
Stitches: 206
Thread used: 3.94ft

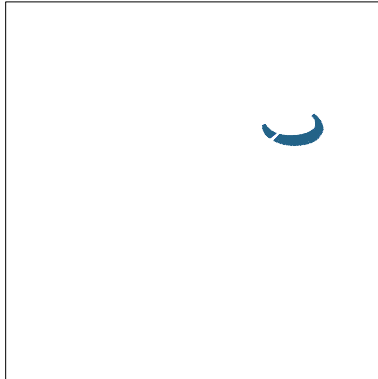

Stop #: 11
Code: Navy Blue
Name: PMS 2766
Chart: Madeira Classic 1242
Stitches: 179
Thread used: 2.82ft

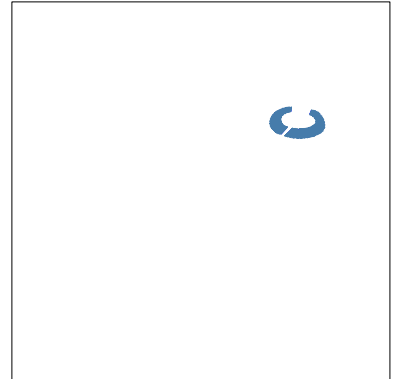

Stop #: 12
Code: Sky Blue
Name: PMS 311
Chart: Madeira Classic 1094
Stitches: 222
Thread used: 3.60ft

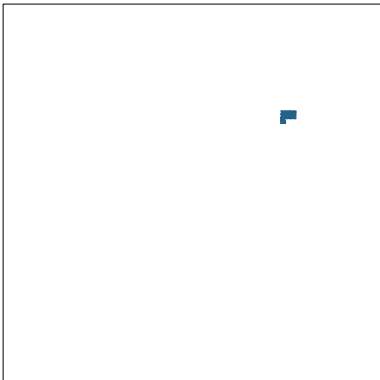

Stop #: 13
Code: Navy Blue
Name: PMS 2766
Chart: Madeira Classic 1242
Stitches: 54
Thread used: 0.79ft

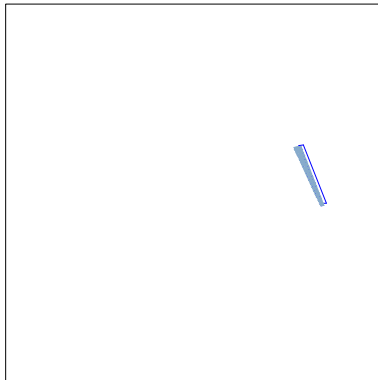

Stop #: 14
Code: Orange
Name: PMS 151
Chart: Madeira Classic 1278
Stitches: 102
Thread used: 1.40ft

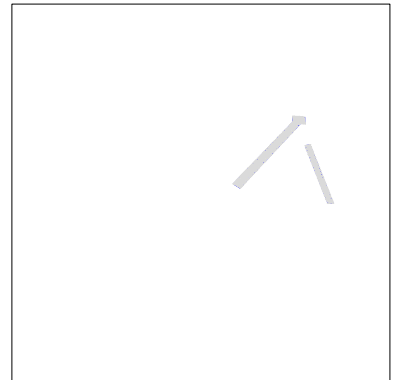

Stop #: 15
Code: White
Name:
Chart: Madeira Classic 1005
Stitches: 284
Thread used: 4.34ft

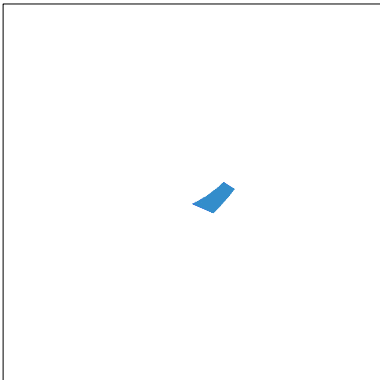

Stop #: 16
Code: New Blue
Name: PMS 2718
Chart: Madeira Classic 1143
Stitches: 81
Thread used: 1.81ft

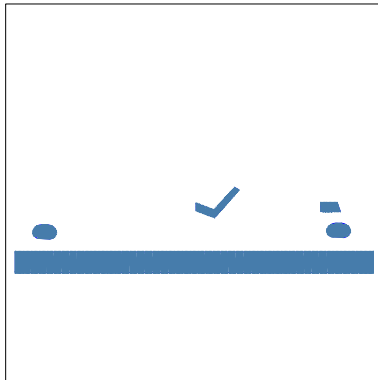

Stop #: 17
Code: Sky Blue
Name: PMS 311
Chart: Madeira Classic 1094
Stitches: 1,090
Thread used: 27.77ft

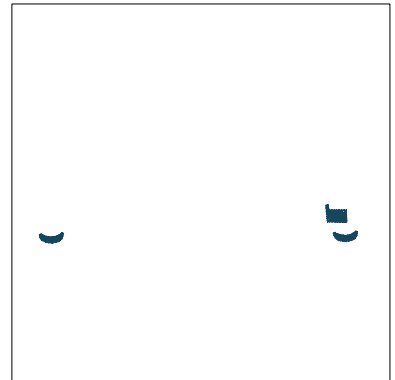

Stop #: 18
Code: Dark Blue
Name: PMS 295
Chart: Madeira Classic 1376
Stitches: 218
Thread used: 2.93ft